

# TASCAM

D01418701A

# BD-MP1MKII

## PROFESSIONAL BLU-RAY DISC™ PLAYER

OWNER'S MANUAL

ENGLISH

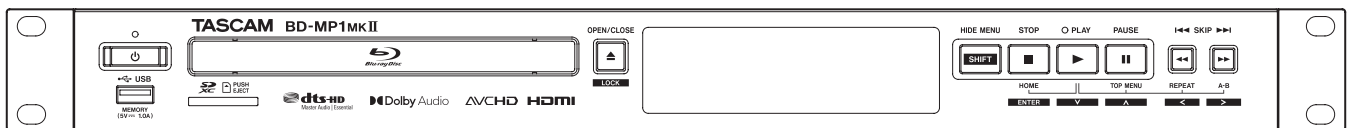

## Trademarks and copyrights

- It is forbidden by law to copy, broadcast, show, broadcast on cable, play in public, or rent copyrighted material without permission. Commercial BD-video/DVD-video discs are copy-protected, and any recordings made from these discs will be distorted. This item incorporates copy protection technology that is protected by U.S. patents and other intellectual property rights of Rovi Corporation. Reverse engineering and disassembly are prohibited.
- This product incorporates copy protection technology that is protected by U.S. patents and other intellectual property rights of Rovi Corporation. The use of Rovi Corporation's copy protection technology in the product must be authorized by Rovi Corporation. Reverse engineering and disassembly are prohibited.
- THIS PRODUCT IS LICENSED UNDER THE AVC PATENT PORTFOLIO LICENSE FOR THE PERSONAL USE OF A CONSUMER OR OTHER USES IN WHICH IT DOES NOT RECEIVE REMUNERATION TO (i) ENCODE VIDEO IN COMPLIANCE WITH THE AVC STANDARD ("AVC VIDEO") AND/OR (ii) DECODE AVC VIDEO THAT WAS ENCODED BY A CONSUMER ENGAGED IN A PERSONAL ACTIVITY AND/OR WAS OBTAINED FROM A VIDEO PROVIDER LICENSED TO PROVIDE AVC VIDEO. NO LICENSE IS GRANTED OR SHALL BE IMPLIED FOR ANY OTHER USE. ADDITIONAL INFORMATION MAY BE OBTAINED FROM MPEG LA, L.L.C. SEE [HTTP://WWW.MPEGLA.COM](http://www.mpegla.com)
- THIS PRODUCT IS LICENSED UNDER THE VC-1 PATENT PORTFOLIO LICENSE FOR THE PERSONAL AND NON-COMMERCIAL USE OF A CONSUMER TO (i) ENCODE VIDEO IN COMPLIANCE WITH THE VC-1 STANDARD ("VC-1 VIDEO") AND/OR (ii) DECODE VC-1 VIDEO THAT WAS ENCODED BY A CONSUMER ENGAGED IN A PERSONAL AND NON-COMMERCIAL ACTIVITY AND/OR WAS OBTAINED FROM A VIDEO PROVIDER LICENSED TO PROVIDE VC-1 VIDEO. NO LICENSE IS GRANTED OR SHALL BE IMPLIED FOR ANY OTHER USE. ADDITIONAL INFORMATION MAY BE OBTAINED FROM MPEG LA, L.L.C. SEE [HTTP://WWW.MPEGLA.COM](http://www.mpegla.com)
- THIS PRODUCT IS LICENSED UNDER THE VC-1 PATENT PORTFOLIO LICENSE FOR THE PERSONAL AND NON-COMMERCIAL USE OF A CONSUMER TO (i) ENCODE VIDEO IN COMPLIANCE WITH THE VC-1 STANDARD ("VC-1 VIDEO") AND/OR (ii) DECODE VC-1 VIDEO THAT WAS ENCODED BY A CONSUMER ENGAGED IN A PERSONAL AND NON-COMMERCIAL ACTIVITY AND/OR WAS OBTAINED FROM A VIDEO PROVIDER LICENSED TO PROVIDE VC-1 VIDEO. NO LICENSE IS GRANTED OR SHALL BE IMPLIED FOR ANY OTHER USE. ADDITIONAL INFORMATION MAY BE OBTAINED FROM MPEG LA, L.L.C. SEE [HTTP://WWW.MPEGLA.COM](http://www.mpegla.com)
- Cinavia™

### Cinavia Notice

This product uses Cinavia technology to limit the use of unauthorized copies of some commercially-produced film and videos and their soundtracks. When a prohibited use of an unauthorized copy is detected, a message will be displayed and playback or copying will be interrupted. More information about Cinavia technology is provided at the Cinavia Online Consumer Information Center at <http://www.cinavia.com>. To request additional information about Cinavia by mail, send a postcard with your mailing address to: Cinavia Consumer Information Center, P.O. Box 86851, San Diego, CA, 92138, USA. This product incorporates proprietary technology under license from Verance Corporation and is protected by U.S. Patent 7,369,677 and other U.S. and worldwide patents issued and pending as well as copyright and trade secret protection for certain aspects of such technology. Cinavia is a trademark of Verance Corporation. Copyright 2004-2016 Verance Corporation. All rights reserved by Verance. Reverse engineering or disassembly is prohibited.

- Dolby, Dolby Audio, and the double-D symbol are trademarks of Dolby Laboratories Licensing Corporation. Manufactured under license from Dolby Laboratories.



- For DTS patents, see <http://patents.dts.com>. Manufactured under license from DTS Licensing Limited. DTS, DTS-HD, the Symbol, & DTS and the Symbol together are registered trademarks, and DTS-HD Master Audio | Essential is a trademark of DTS, Inc. © DTS, Inc. All Rights Reserved.



- Blu-ray Disc™, Blu-ray™, Blu-ray 3D™, BD-Live™, BONUSVIEW™ word marks and logos are trademarks of the Blu-ray Disc Association.



- "DVD Logo" is a trademark of DVD Format/Logo Licensing Corporation.



- HDMI, the HDMI logo and High-Definition Multimedia Interface are trademarks or registered trademarks of HDMI LLC in the USA and other countries.



- Oracle and Java are registered trademarks of Oracle Corporation and its subsidiary and affiliated companies in the USA and other countries. Names, including those of companies and products, in this document might be trademarks or registered trademarks.



- AVCHD and the AVCHD logo are trademarks of Panasonic Corporation and Sony Corporation.



- "x.v.Color" and "x.v.Color" logo are trademarks of Sony Corporation.







- Supply of this product does not convey a license nor imply any right to distribute MPEG Layer-3 compliant content created with this product in revenue-generating broadcast systems (terrestrial, satellite, cable and/or other distribution channels), streaming applications (via Internet, intranets and/or other networks), other content distribution systems (pay-audio or audio-on-demand applications and the like) or on physical media (compact discs, digital versatile discs, semiconductor chips, hard drives, memory cards and the like). An independent license for such use is required. For details, please visit <http://mp3licensing.com>.
- SDXC Logo is a trademark of SD-3C LLC.



- TASCAM is a registered trademark of TEAC Corporation.
- Other company names, product names and logos in this document are the trademarks or registered trademarks of their respective owners.

# IMPORTANT SAFETY INSTRUCTIONS

 <div style="border: 1px solid black; padding: 2px; display: inline-block; text-align: center;"> <b>CAUTION</b>  <small>RISK OF ELECTRIC SHOCK DO NOT OPEN</small> </div> 	<p>CAUTION: TO REDUCE THE RISK OF ELECTRIC SHOCK, DO NOT REMOVE COVER (OR BACK). NO USER-SERVICEABLE PARTS INSIDE. REFER SERVICING TO QUALIFIED SERVICE PERSONNEL.</p>
	<p>The lightning flash with arrowhead symbol, within equilateral triangle, is intended to alert the user to the presence of uninsulated "dangerous voltage" within the product's enclosure that may be of sufficient magnitude to constitute a risk of electric shock to persons.</p>
	<p>The exclamation point within an equilateral triangle is intended to alert the user to the presence of important operating and maintenance (servicing) instructions in the literature accompanying the appliance.</p>

**WARNING: TO PREVENT FIRE OR SHOCK HAZARD, DO NOT EXPOSE THIS APPLIANCE TO RAIN OR MOISTURE.**

1. Read these instructions.
2. Keep these instructions.
3. Heed all warnings.
4. Follow all instructions.
5. Do not use this apparatus near water.
6. Clean only with dry cloth.
7. Do not block any ventilation openings. Install in accordance with the manufacturer's instructions.
8. Do not install near any heat sources such as radiators, heat registers, stoves, or other apparatus (including amplifiers) that produce heat.
9. Do not defeat the safety purpose of the polarized or grounding-type plug. A polarized plug has two blades with one wider than the other. A grounding type plug has two blades and a third grounding prong. The wide blade or the third prong are provided for your safety. If the provided plug does not fit into your outlet, consult an electrician for replacement of the obsolete outlet.
10. Protect the power cord from being walked on or pinched particularly at plugs, convenience receptacles, and the point where they exit from the apparatus.
11. Only use attachments/accessories specified by the manufacturer.
12. Use only with the cart, stand, tripod, bracket, or table specified by the manufacturer, or sold with the apparatus. When a cart is used, use caution when moving the cart/apparatus combination to avoid injury from tip-over.



13. Unplug this apparatus during lightning storms or when unused for long periods of time.
  14. Refer all servicing to qualified service personnel. Servicing is required when the apparatus has been damaged in any way, such as power-supply cord or plug is damaged, liquid has been spilled or objects have fallen into the apparatus, the apparatus has been exposed to rain or moisture, does not operate normally, or has been dropped.
- The apparatus draws nominal non-operating power from the AC outlet with its POWER or STANDBY/ON switch not in the ON position.
  - The mains plug is used as the disconnect device, the disconnect device shall remain readily operable.
  - Caution should be taken when using earphones or headphones with the product because excessive sound pressure (volume) from earphones or headphones can cause hearing loss.
  - If you are experiencing problems with this product, contact TEAC for a service referral. Do not use the product until it has been repaired.

**CAUTION**

- Do not expose this apparatus to drips or splashes.
- Do not place any objects filled with liquids, such as vases, on the apparatus.
- Do not install this apparatus in a confined space such as a book case or similar unit.
- The apparatus should be located close enough to the AC outlet so that you can easily grasp the power cord plug at any time.
- If the product uses batteries (including a battery pack or installed batteries), they should not be exposed to sunshine, fire or excessive heat.
- CAUTION for products that use replaceable lithium batteries: there is danger of explosion if a battery is replaced with an incorrect type of battery. Replace only with the same or equivalent type.
- Installed battery subjected to extremely low air pressure may result in an explosion or the leakage of flammable liquid or gas.

**WARNING**

Products with Class I construction are equipped with a power supply cord that has a grounding plug. The cord of such a product must be plugged into an AC outlet that has a protective grounding connection.

**WARNING**

- To prevent possible hearing damage, do not listen at high volume levels for long periods.



**WARNING**

This equipment is not suitable for use in locations where children are likely to be present.

## RACK-MOUNTING THE UNIT

Use the supplied rack-mounting kit to mount the unit in a standard 19-inch rack, as shown below. Remove the feet of the unit before mounting.

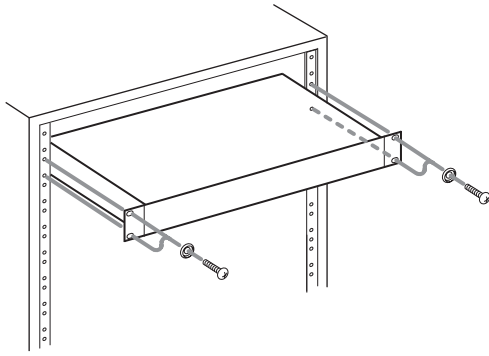

### ATTENTION

- Leave 1U of space above the unit for ventilation.
- Allow at least 10 cm (4 in) at the rear of the unit for ventilation.

### For U.S.A.

#### Supplier's Declaration of Conformity

Model Number: BD-MP1MKII  
 Trade Name: TASCAM  
 Responsible party: TEAC AMERICA, INC.  
 Address: 10410 Pioneer Blvd., Unit #3, Santa Fe Springs, California 90670, U.S.A  
 Telephone number: 1-323-726-0303



This device complies with Part 15 of the FCC Rules. Operation is subject to the following two conditions: (1) this device may not cause harmful interference, and (2) this device must accept any interference received, including interference that may cause undesired operation.

### INFORMATION TO THE USER

This equipment has been tested and found to comply with the limits for a Class B digital device, pursuant to Part 15 of the FCC Rules. These limits are designed to provide reasonable protection against harmful interference in a residential installation. This equipment generates, uses, and can radiate radio frequency energy and, if not installed and used in accordance with the instructions, may cause harmful interference to radio communications. However, there is no guarantee that interference will not occur in a particular installation. If this equipment does cause harmful interference to radio or television reception, which can be determined by turning the equipment off and on, the user is encouraged to try to correct the interference by one or more of the following measures.

- Reorient or relocate the receiving antenna.
- Increase the separation between the equipment and receiver.
- Connect the equipment into an outlet on a circuit different from that to which the receiver is connected.
- Consult the dealer or an experienced radio/TV technician for help.

### CAUTION

Changes or modifications to this equipment not expressly approved by TEAC CORPORATION for compliance could void the user's authority to operate this equipment.

## LASER INFORMATION

This laser product is a consumer laser product according to EN 50689 and complies with all consumer laser product requirements except child appealing products.

This product contains a laser system and is classified as a CLASS 1 LASER PRODUCT according to IEC 60825-1:2014. This class does not require special attention in normal use. Do not take apart to prevent being exposed to the laser beam.

### Notes on Laser Product

This product has been designed and manufactured according to FDA regulations "title 21, CFR, chapter 1, subchapter J, based on the Radiation Control for Health and Safety Act of 1968", and is classified as a class 1 laser product. There is no hazardous invisible laser radiation during operation because invisible laser radiation emitted inside of this product is completely confined in the protective housings.

The label required in this regulation is shown at ①.

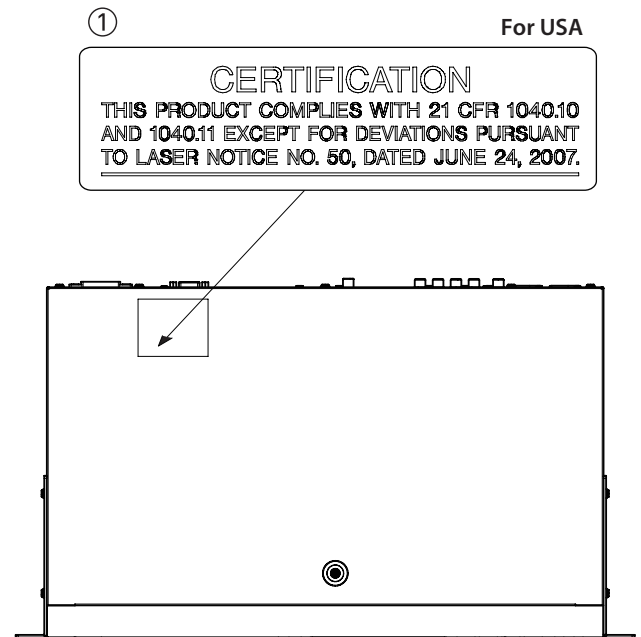

### ATTENTION

- DO NOT REMOVE THE PROTECTIVE HOUSING USING A SCREWDRIVER.
- USE OF CONTROLS OR ADJUSTMENTS OR PERFORMANCE OF PROCEDURES OTHER THAN THOSE SPECIFIED HEREIN MAY RESULT IN HAZARDOUS RADIATION EXPOSURE.

#### Optical pickup

Type: SL6167  
 Manufacturer: Sony Corporation  
 Laser output: Less than 100 mW on the objective lens (CD)  
 Less than 100 mW on the objective lens (DVD)  
 Wavelength: 770 - 800 nm (CD) typ.  
 650 - 664 nm (DVD) typ.

#### Optical pickup

Type: SLD3134VL  
 Manufacturer: Sony Corporation  
 Laser output: Less than 700 mW on the objective lens (BD)  
 Wavelength: 400 - 410 nm (BD) typ.

**Optical pickup**

Type: SL6169

Manufacturer: Sony Corporation

Laser output: Less than 150 mW on the objective lens (CD)  
Less than 150 mW on the objective lens (DVD)

Wavelength: 770 - 800 nm (CD) typ.  
650 - 664 nm (DVD) typ.

**Optical pickup**

Type: SLD3135VL

Manufacturer: Sony Corporation

Laser output: Less than 700 mW on the objective lens (BD)

Wavelength: 400 - 410 nm (BD) typ.

**IN USA/CANADA, USE ONLY ON 120 V SUPPLY.**

**For Canada**

THIS CLASS B DIGITAL APPARATUS COMPLIES WITH CANADIAN ICES-003.

CET APPAREIL NUMERIQUE DE LA CLASSE B EST CONFORME A LA NORME NMB-003 DU CANADA.



This product complies with the European Directives request and the other Commission Regulations.



This product complies with applicable UK regulations.

## CAUTIONS ABOUT BATTERIES

This product uses batteries. Misuse of batteries could cause a leak, rupture or other trouble. Always abide by the following precautions when using batteries.

- Never recharge non-rechargeable batteries. The batteries could rupture or leak, causing fire or injury.
- When installing batteries, pay attention to the polarity indications (plus/minus (+/-) orientation), and install them correctly in the battery compartment as indicated. Putting them in backward could make the batteries rupture or leak, causing fire, injury or stains around them.
- When you store or dispose batteries, isolate their terminals with insulation tape or something like that to prevent them from contacting other batteries or metallic objects.
- When throwing used batteries away, follow the disposal instructions indicated on the batteries and the local disposal laws.
- Do not use batteries other than those specified. Do not mix and use new and old batteries or different types of batteries together. The batteries could rupture or leak, causing fire, injury or stains around them.
- Do not carry or store batteries together with small metal objects. The batteries could short, causing leak, rupture or other trouble.
- Do not heat or disassemble batteries. Do not put them in fire or water. Batteries could rupture or leak, causing fire, injury or stains around them.
- If the battery fluid leaks, wipe away any fluid on the battery case before inserting new batteries. If the battery fluid gets in an eye, it could cause loss of eyesight. If fluid does enter an eye, wash it out thoroughly with clean water without rubbing the eye and then consult a doctor immediately. If the fluid gets on a person's body or clothing, it could cause skin injuries or burns. If this should happen, wash it off with clean water and then consult a doctor immediately.
- The unit power should be off when you install and replace batteries.
- Remove the batteries if you do not plan to use the unit for a long time. Batteries could rupture or leak, causing fire, injury or stains around them. If the battery fluid leaks, wipe away any fluid on the battery compartment before inserting new batteries.
- Do not disassemble a battery. The acid inside the battery could harm skin or clothing.

## For European Customers

### Disposal of electrical and electronic equipment and batteries and/or accumulators

- (a) All electrical/electronic equipment and waste batteries/accumulators should be disposed of separately from the municipal waste stream via collection facilities designated by the government or local authorities.
- (b) By disposing of electrical/electronic equipment and waste batteries/accumulators correctly, you will help save valuable resources and prevent any potential negative effects on human health and the environment.
- (c) Improper disposal of waste electrical/electronic equipment and batteries/accumulators can have serious effects on the environment and human health because of the presence of hazardous substances in the equipment.

- (d) The Waste Electrical and Electronic Equipment (WEEE) symbols, which show wheeled bins that have been crossed out, indicate that electrical/electronic equipment and batteries/accumulators must be collected and disposed of separately from household waste.



If a battery or accumulator contains more than the specified values of lead (Pb), mercury (Hg), and/or cadmium (Cd) as defined in the Battery Directive (2006/66/EC, 2013/56/EU), then the chemical symbols for those elements will be indicated beneath the WEEE symbol.



- (e) Return and collection systems are available to end users. For more detailed information about the disposal of old electrical/electronic equipment and waste batteries/accumulators, please contact your city office, waste disposal service or the shop where you purchased the equipment.

---

# Contents

---

IMPORTANT SAFETY INSTRUCTIONS .....	3	Types of media that can be played .....	28
Introduction .....	8	Playable file formats (video, audio and image) .....	28
Included items .....	8	Playing media .....	28
Conventions used in this manual .....	8	Loading discs .....	28
Features .....	8	Automatic playback (power-on-play) overview .....	28
Precautions for placement and use .....	9	Playing video discs .....	29
Using the TEAC Global Site .....	9	Pausing playback .....	29
Product registration .....	9	Stopping playback .....	29
Beware of condensation .....	9	Searching backward/forward .....	29
Cleaning the unit .....	9	Skipping to the previous or next chapter/track .....	29
Notes about power supplies .....	9	Repeating playback of part of a scene or track .....	29
About TASCAM customer support service .....	9	Repeating playback of a chapter, title or track .....	29
SD cards and USB flash drives .....	9	Jumping to a specific playback time, scene or track .....	30
Precautions for use .....	9	Playing USB flash drives and SD cards .....	30
Handling discs .....	10	Playing USB flash drive/SD cards playlists .....	31
Names and functions of parts .....	11	Using program playback .....	33
Front panel .....	11	Setting bookmarks .....	34
Rear panel .....	12	Jumping to bookmarks .....	34
Wireless remote control (TASCAM RC-BDMP1MKII) .....	13	Deleting bookmarks .....	34
HOME screen .....	15	Adjusting the volume from the unit .....	34
Disc .....	15	Muting with this unit .....	34
Media .....	15	Overview of ON SCREEN information bar .....	35
Playing files on SD cards and USB flash drives .....	16	Speaker Settings .....	36
Settings .....	17	Configuration .....	36
General Settings .....	17	Test Tone .....	37
Display Settings .....	20	Network connection overview .....	38
Audio Settings .....	22	Option menus .....	39
Making connections .....	24	Basic option menu operations .....	39
Installing rackmount ears .....	24	General Settings .....	39
Display .....	25	Troubleshooting .....	43
Normal state .....	25	Specifications .....	44
During playback .....	25	General .....	44
Preparing the remote control .....	26	Outputs .....	44
Installing batteries .....	26	Control input/output .....	45
When to replace batteries .....	26	Audio performance .....	45
Battery precautions .....	26	Other .....	45
Using the wireless remote control .....	26	Dimensional drawings .....	46
Turning the unit on and putting it into standby .....	26		
Turning the unit on .....	26		
Putting the unit into standby .....	26		
Loading and removing discs .....	26		
Loading discs .....	26		
Ejecting discs .....	26		
Inserting and removing SD cards .....	27		
Inserting SD cards .....	27		
Removing SD cards .....	27		
SD card write protection switches .....	27		
Connecting and disconnecting USB flash drives .....	27		
Connecting USB flash drives .....	27		
Disconnecting USB flash drives .....	27		
Lock functions .....	27		
When locked .....	27		
Remote control overview .....	27		
BD-Live overview .....	28		

---

## Introduction

---

Thank you very much for purchasing the TASCAM BD-MP1MKII. Before using this unit, read this Owner's Manual carefully so that you will be able to use it correctly and enjoy working with it for many years. After you have finished reading this manual, please keep it in a safe place for future reference. You can also download this Owner's Manual from the TEAC Global Site.



**BD-MP1 MKII**  
<https://tascam.jp/int/product/bd-mp1mkii/docs>

---

## Included items

---

This product includes the following items.

Take care when opening the package to avoid damaging the items. Keep the box and packing materials for transportation in the future.

Please contact the store where you purchased this unit if any of these items are missing or have been damaged during transportation.

- Main unit × 1
- Power cord × 1
- Wireless remote control (TASCAM RC-BDMP1MKII) × 1
- AAA batteries × 2
- Rackmount screw kit × 1
  - Items included in kit
    - Rackmount ears (left and right) × 2
    - Screws for ear attachment × 6
    - Screws for attachment to rack × 4
    - Washers (for rack) × 4
- Owner's Manual (this document) including warranty × 1

---

## Conventions used in this manual

---

In this manual, we use the following conventions:

- SD/SDHC/SDXC memory cards are called "SD cards".
- "USB flash drives" are sometimes called "USB drives".
- The CD-DA format is sometimes called the "audio CD" format. In addition, CDs with tracks recorded in the audio CD format are sometimes called "audio CDs".
- CDs with MP3 or WMA files are called "data CDs".
- The input source that is currently selected is called the "current source".
- The folder that is currently selected is called the "current folder".
- As necessary, additional information is provided under TIP, NOTE, ATTENTION and CAUTION headings.

### TIP

These are tips about how to use the unit.

### NOTE

These provide additional explanations and describe special cases.

### ATTENTION

Failure to follow these instructions could result in damage to equipment or lost data, for example.

### CAUTION

Failure to follow these instructions could result in injury.

---

## Features

---

- Supports playback of a variety of Blu-ray, DVD and CD formats
- Supports playback from SD cards and USB flash drives
- Power on play function enables automatic playback of content when turned on
- Seamless repetition of individual chapters, titles and A-B intervals possible
- Various lock functions to prevent accidents caused by misoperation (panel lock, IR lock, tray lock)
- HIDE MENU function can be used to hide the HOME Screen (black screen) after the power is turned on and when discs are loaded
- Ports for USB flash drives available on both front and back
- HDMI output port enables output to monitors and TVs
- Unbalanced RCA and balanced XLR analog audio output jacks
- COAXIAL digital audio output connector supports Dolby Audio and DTS, for example
- Front left and right, center, side left and right, surround back left and right and subwoofer output jacks support 7.1ch surround
- Support for external control through Ethernet/RS-232C
- Play, stop, pause and search functions as well as menu settings can be controlled from front panel
- Compact 1U rackmount size

Information is given about products in this manual only for the purpose of example and does not indicate any guarantees against infringements of third-party intellectual property rights and other rights related to them. TEAC Corporation will bear no responsibility for infringements on third-party intellectual property rights or their occurrence because of the use of these products.

With the exception of personal enjoyment and similar uses, copyrighted materials belonging to third parties cannot be used without permission from the rights holders in accordance with copyright law. Please use the equipment appropriately. TEAC Corporation will bear no responsibility for rights infringements committed by users of this product.

Information about copyrights and licenses related to open source software is included at the end of this document.



---

## Precautions for placement and use

---

- The operating temperature range of this unit is 5–35 °C.
- Do not install this unit in the following types of locations. Doing so could make the sound quality worse or cause malfunction.
  - Locations with frequent vibrations
  - Near windows or other places exposed to direct sunlight
  - Near heaters or other extremely hot places
  - Extremely cold places
  - Very humid or poorly ventilated places
  - Very dusty places
- Install the unit so that it is level.
- To enable good heat dissipation, do not place anything on top of the unit.
- Do not place the unit on top of a power amplifier or other device that generates heat.

---

## Using the TEAC Global Site

---

You can download updates for this unit from the TEAC Global Site:

<https://teac-global.com/>

In the TASCAM Downloads section, select the desired language to open the Downloads website page for that language.

---

## Product registration

---

Please visit the following TASCAM website to register your TASCAM product online.

If you register your product, you will be notified when there is a firmware or software update regarding the registered product.

<https://tascamid.tascam.jp/int/login>

---

## Beware of condensation

---

Condensation could occur if the unit is moved from a cold place to a warm place, it is used immediately after a cold room has been heated or it is otherwise exposed to a sudden temperature change. To prevent this, or if this occurs, let the unit sit for one or two hours at the new room temperature before using it.

---

## Cleaning the unit

---

Use a dry soft cloth to wipe the unit clean. Do not wipe with chemical cleaning cloths, thinner, alcohol or other chemical agents. Doing so could damage the surface or cause discoloration.

---

## Notes about power supplies

---

- Insert the included power cord all the way into the AC IN connector.
- Do not connect a power supply other than one that is AC100V - 240V (50/60Hz).
- Hold the power cord by its plug when connecting or disconnecting it.

---

## About TASCAM customer support service

---

TASCAM products are supported and warranted only in their country/region of purchase.

To receive support after purchase, on the TASCAM Distributors list page of the TEAC Global Site (<https://teac-global.com/>), search for the local company or representative for the region where you purchased the product and contact that organization. When making inquiries, the address (URL) of the shop or web shop where it was purchased and the purchase date are required. Moreover, the warranty card and proof of purchase might also be necessary.

---

## SD cards and USB flash drives

---

This unit can use SD cards and USB flash drives for playback.

A list of SD cards and USB flash drives that have been confirmed for use with this unit can be found on the TEAC Global Site (<https://tascam.jp/int/product/bd-mp1mkii/docs>). Check the page for this product. You can also contact TASCAM customer support service.

---

## Precautions for use

---

SD cards and USB flash drives are delicate media.

In order to avoid damaging SD cards and USB flash drives, please take the following precautions when handling them.

- Do not leave them in extremely hot or cold places.
- Do not leave them in extremely humid places.
- Do not let them get wet.
- Do not put things on top of them or twist them.
- Do not hit them.
- Do not remove or insert them during playback, data transmission or other access.
- When transporting them, put them into cases, for example.

---

## Handling discs

---

- Load discs with their recorded sides down.
- Load discs when the disc tray is completely open.
- Align discs with the tray guide and place them so they are level.
- Do not touch the recorded (unlabeled) side. Fingerprints, oils and other substances can cause errors during playback.
- If fingerprints or dust adhere to the recorded side of a disc, wipe it gently with a soft dry cloth from the center towards the outside edge.
- Dirt on discs can lower video and sound quality, so clean them and always store them in a clean state.
- Do not use any record spray, anti-static solutions, benzene, paint thinner or other chemical agents to clean discs as they could damage the delicate playing surface. It may cause discs to become unplayable.
- Do not apply labels or other materials to discs. Do not use discs that have glue or sticky residue from having had tape, stickers or other materials applied to their surface. Such discs could become stuck in the unit or cause it to malfunction.
- Never use commercially-available disc stabilizers. Using stabilizers with this player could prevent playback or damage the unit.
- Do not use cracked discs.
- Do not use discs that are irregularly shaped, including discs shaped like hearts, business cards and octagons because using such discs could cause the unit to malfunction.

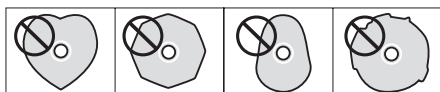

- Copy Control CDs have been sold by several record companies in an attempt to protect their copyrights. Since some of these discs do not comply with the CD specifications, they may not be playable on the unit.

### ATTENTION

- Only load one disc at a time. Loading two or more discs at the same time could cause malfunction and damage the discs.
- Do not push the disc tray in when the power is in standby. Doing so could cause malfunction.

### NOTE

If a disc that cannot be played back or a disc that is upside down is loaded in the unit, "UNK DISC" will appear on the display.

# Names and functions of parts

## Front panel

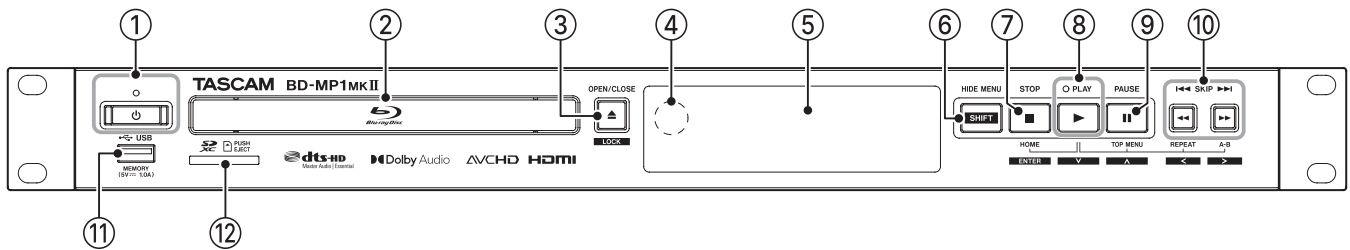

### ① **⏻ button and indicator**

Use this to turn the unit on and put it into standby. The indicator lights red when the power is in standby and green when on.

### **⚠ CAUTION**

Before turning the unit on, lower the volumes of connected equipment to their minimum levels. Failure to do so could result in a sudden loud noise that could harm hearing, for example.

### **⚠ ATTENTION**

Do not turn the power on/off when the unit is playing any media or reading data from an SD card or USB flash drive. Doing so could make the unit stop operating properly and cause data on the SD card or USB flash drive to be damaged.

### ② **Disc tray**

Press the OPEN/CLOSE [LOCK] button to open the disc tray and load/remove a disc. To close the disc tray, press the OPEN/CLOSE [LOCK] button.

### ③ **OPEN/CLOSE [LOCK] (▲) button**

Use to open and close the disc tray usually. Press while pressing the HIDE MENU [SHIFT] button to enable the front panel lock function. Do this again to disable the lock function.

### ④ **Remote control signal receiver**

Signals from remote controls are received here. When operating the remote control, point it toward this receiver.

### ⑤ **Display**

This shows various types of information.

### ⑥ **HIDE MENU [SHIFT] button**

Press this button to turn on the HIDE MENU function, which stops display of the HOME screen (the screen will remain black). When the HIDE MENU function is on, an \* will be shown at the right end of the bottom line on the display, and characters and icons for playback, searching and skipping, for example will not be shown on the monitor. Press this again to turn off the function.

In addition, while pressing this button, press the ③ or ⑦-⑩ buttons to use the functions shown in the white rectangles with black characters (shift mode).

Button combination	Button press	Behavior
SHIFT	▲	Simultaneous press Changes the LOCK setting.
SHIFT	■	Simultaneous press Confirms or selects menu items.
SHIFT	▶	Simultaneous press ∨ (down)
SHIFT	⏸	Simultaneous press ∧ (up)
SHIFT	◀◀	Simultaneous press < (left)
SHIFT	▶▶	Simultaneous press > (right)

### ⑦ **STOP [ENTER] (HOME) (■) button**

Press this when a video file is being played, paused or searched to stop the current operation, stop the unit and close the video.

Pressing this when a disc is stopped will return to the HOME screen, and pressing it when a file is stopped will return to the media screen.

When an audio file is being played, paused or searched, press to stop playback or searching.

When the HOME screen or a Settings screen is open, press this at the same time as the HIDE MENU [SHIFT] button to enable shift mode and use this as the ENTER button.

### ⑧ **PLAY [∨] (▶) button/indicator**

Press when stopped or in playback standby to start playback. The indicator lights green during playback and is unlit at all other times.

When the HOME screen or a Settings screen is open, press this at the same time as the HIDE MENU [SHIFT] button to enable shift mode and use this as the move cursor down (∨) button. While pressing this button, press a button shown connected to it (⑦, ⑨ or ⑩) to use its special function.

Button combination	Button press	Behavior
▶	■	Simultaneous press Displays the HOME screen.
▶	⏸	Simultaneous press Displays the top menu/title menu of the disc.
▶	◀◀	Simultaneous press Selects repeat modes.
▶	▶▶	Simultaneous press Plays back a defined section between point A and B repeatedly.

### ⑨ **PAUSE [∧] (⏸) (TOP MENU) button**

Press when playing back to pause playback. When the HOME screen or a Settings screen is open, press this at the same time as the HIDE MENU [SHIFT] button to enable shift mode and use this as the move cursor up (∧) button.

### ⑩ **SKIP ◀◀/▶▶ [◀/▶] (◀◀/▶▶) (REPEAT/A-B) buttons**

Press when playing back or paused to skip to the previous or next chapter or file. (Playback will start after skipping.)

Press and hold when playing back or paused to search backward/forward. The search speed changes (among 5 speeds) each time the button is pressed and held. (To resume playing or to pause when searching, press the PLAY [∨] (▶) or PAUSE [∧] (⏸) button.)

When the HOME screen or a Settings screen is open, press this at the same time as the HIDE MENU [SHIFT] button to enable shift mode and use these as move cursor left/right (</>) buttons.

### ⑪ USB port

Connect/disconnect USB flash drives here. Audio, video and other files can be played back from a connected USB flash drive. Moreover, this can be used to load update files for firmware updates.

### ⑫ SD card slot

Insert an SD card in this slot. Audio, video and other files can be played back from a connected SD card.

## Rear panel

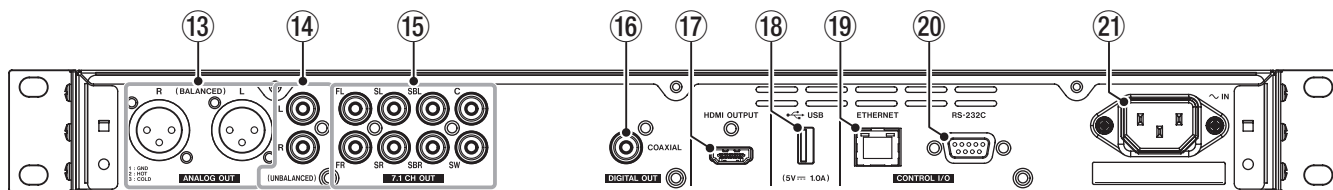

### ⑬ ANALOG OUT (BALANCED) L/R jacks

These are balanced XLR analog output jacks. These transmit balanced 7.1CH OUT FL/FR audio signals to external speakers and amplifiers, for example. Use XLR cables for connection.

#### NOTE

If you want to use downmixed audio when the selected speaker settings channel configuration is not 2.x, use digital signals from the DIGITAL OUT (COAXIAL) connector.

### ⑭ ANALOG OUT (UNBALANCED) L/R jacks

These are unbalanced RCA analog output jacks. These transmit the same audio signals as output from the 7.1CH OUT FL/FR connectors to external speakers and amplifiers, for example. Use RCA cables for connection.

#### NOTE

If you want to use downmixed audio when the selected speaker settings channel configuration is not 2.x, use digital signals from the DIGITAL OUT (COAXIAL) connector.

### ⑮ 7.1CH OUT (unbalanced) connectors

These are 7.1 unbalanced RCA analog output jacks. These transmit 8 channels of audio signals to a 7.1 surround system. Use RCA cables for connection.

### ⑯ DIGITAL OUT (COAXIAL) connector

This is a coaxial digital audio output connector. This transmits digital audio signals to a television. Use a coaxial cable (75Ω) for connection. The maximum channel count for this connector is 5.1.

### ⑰ HDMI OUT port

Audio/video signals are transmitted from the HDMI port. Use an HDMI cable for connection.

#### NOTE

Audio can be output from the ANALOG OUT jacks, the 7.1CH OUT jacks, the HDMI OUT connector and the DIGITAL OUT (COAXIAL) at the same time.

### ⑱ USB port

Connect/disconnect USB flash drives here. Audio, video and other files can be played back from a connected USB flash drive. Moreover, this can be used to load update files for firmware updates.

### ⑲ Ethernet connector

This is an Ethernet port. Use to connect this unit to a network and to control it from a computer. Moreover, BD-Live contents can also be accessed with an Internet connection. Use an STP cable that is category 5e or higher for connection.

### ⑳ RS-232C connector

This is a 9-pin D-sub RS-232C control input/output connector. A computer can be used to control this unit by connecting to it with an RS-232C cable.

### ㉑ AC IN connector

Connect the included power cord here.

## Wireless remote control (TASCAM RC-BDMP1MKII)

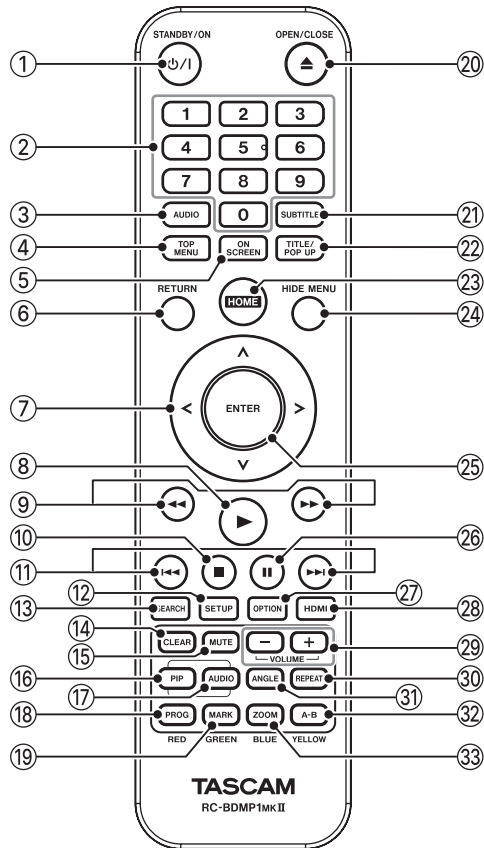

### ① **⏻/⏻ (STANDBY/ON) button**

This has the same function as the **⏻** button on the main unit.

### **⚠ CAUTION**

Before turning the unit on, lower the volumes of connected equipment to their minimum levels. Failure to do so could result in a sudden loud noise that could harm hearing, for example.

### ② **Number (0–9) buttons**

The number buttons can be used during media playback to designate and select chapter and audio track numbers (except when options or submenus are shown on the screen). (see “Jumping to a specific playback time, scene or track” on page 30)

### ③ **AUDIO button**

Press during video disc playback to show the current audio settings at the top left of the monitor screen.

Press this button repeatedly to show the audio settings that can be used and to switch sound sources.

The audio settings shown depend on the settings supported by the video disc.

For example, stereo, mono, left channel and right channel can be selected for DVDs, and DTS-HD MA (master audio) or Dolby Digital can be selected in various languages for Blu-ray discs.

### ④ **TOP MENU button**

Press during playback of a video disc to show the top menu screen.

Use the **</>/^/∨** cursor buttons to move in menus, and use the **ENTER** button to confirm selection.

### ⑤ **ON SCREEN button**

Press during video disc playback to show an information bar that can be used to check the current status at the top of the monitor screen.

### ⑥ **RETURN button**

Press when using the HOME screen to return to the previous menu. Press repeatedly to return to the top menu.

### ⑦ **Cursor buttons </>/^/∨**

Press when the HOME screen is open to move between setting items.

Moving in menus is also possible on video file top menu and title menu screens as well as option menu screens during playback.

### ⑧ **▶ button**

This has the same function as the **PLAY [∨] (▶)** button on the main unit.

### ⑨ **◀/▶ buttons**

Press when playing back or paused to search backward/forward.

- When searching backward/forward in a video file, press the **PAUSE (⏸)** button to pause playback. In this state, press the **▶** button to resume playback, or press the **◀** button to resume backward searching.

- When searching backward/forward in an audio file, press the **PAUSE (⏸)** button to pause playback. Press it again to resume searching backward/forward.

### ⑩ **■ button**

This has the same function as the **STOP (■)** button on the main unit.

### ⑪ **◀◀/▶▶ buttons**

Press when playing back or paused to skip to the previous or next chapter or file. (Playback will start after skipping.) In video files, this will move to the previous or next chapter. In audio files, this will move to the previous or next file.

### ⑫ **SETUP button**

Press when using the HOME screen, playing back, paused or searching backward/forward to open the Settings screens. Press again to return to the original screen.

### **NOTE**

When the **HIDE MENU** function is on, pressing this button will not open the Settings screens.

### ⑬ **SEARCH button**

Press when playing back or paused to designate a specific playback time within the current medium.

Press this button to open an information bar at top of the monitor screen. The cursor will appear for 20 seconds in the time display area (upper right) of the information bar. Press the **ENTER** button while the cursor appears and use the number buttons to input any playback time. To move among hours, minutes and seconds, use the **</>** cursor buttons while the cursor appears.

### ⑭ **CLEAR button**

This clears the value in the field being input.

In the bookmark list, this deletes the selected bookmark.

### ⑮ **MUTE button**

This mutes the volume of the main unit. (An icon appears at the top of the monitor.)

Press this again to unmute.

### ⑯ **PIP button**

This turns the picture-in-picture function on/off. This function can only be used with discs that support it.

### ⑰ **AUDIO button (2nd)\***

This selects the audio language used with the picture-in-picture function. This function can only be used with discs that support it.

\* This is different from the ③ **AUDIO** button function.

⑱ **PROG/RED button**

This opens the program page where tracks can be selected for playback in a specific order.

⑲ **MARK/GREEN button**

During video file playback, press this button to add a bookmark at any point. (Up to 12 can be added.)

⑳ **▲ OPEN/CLOSE button**

This has the same function as the OPEN/ CLOSE [LOCK] button on the main unit.

㉑ **SUBTITLE button**

Press during video file playback to change the subtitle display style.

The settings that can be used depend on the subtitle languages supported by the video.

㉒ **TITLE/POP UP button**

When a media file is playing or paused, press to show the title menu.

Use the </>/^/∨ cursor buttons to move in menus, and use the ENTER button to confirm selection.

㉓ **HOME button**

Press this button to stop the current operation and return to the HOME screen.

㉔ **HIDE MENU button**

This has the same function as the HIDE/MENU [SHIFT] button on the main unit.

㉕ **ENTER button**

This functions as the execute button on the HOME screen and every menu screen.

㉖ **II button**

This has the same function as the PAUSE [^] (II) (TOP MENU) button on the main unit.

㉗ **OPTION button**

When playing back or paused, press to open the Option Menu screen.

Use the </>/^/∨ cursor buttons to move in menus, and use the ENTER button to confirm selection.

㉘ **HDMI button**

Press this button repeatedly to cycle through the following screen resolutions.

480i/576i, 480p/576p, 720p, 1080i, 1080p

㉙ **-/+ (VOLUME) buttons**

Press when playing back or paused to adjust the audio volume.

㉚ **REPEAT button**

Press when playing back or paused to enable repeat playback mode for the selected chapter, title or track. An icon will appear at the top of the monitor. Press this button repeatedly to enable selection of repeat playback conditions.

(see "Jumping to a specific playback time, scene or track" on page 30)

㉛ **ANGLE button**

Press when a video file that has been recorded with multiple angles is playing or paused to show the currently selected angle. An icon will appear at the top of the monitor. Press this button repeatedly to enable selection of recorded angles.

㉜ **A-B/YELLOW button**

Press the A-B button during disc playback to repeat playback of part of a scene or track.

㉝ **ZOOM/BLUE button**

Press when a selected image is shown to zoom in/out. (The size being displayed currently is shown at the top of the monitor.)

Press this button repeatedly to change the zoom to the following sizes.

(No zoom when no indicator is shown on the monitor.)

Reduction (shown on monitor): 1/4, 1/3, 1/2

Magnification (shown on monitor): 2x, 3x, 4x

## HOME screen

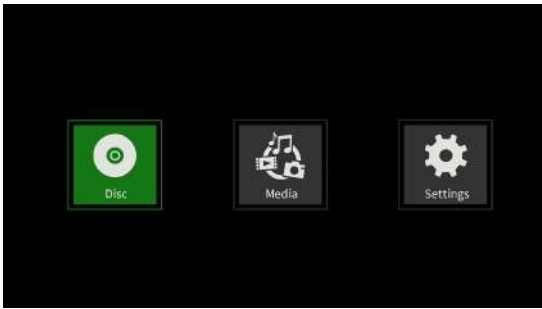

Select, play and check media files, set up the unit and conduct other functions on the HOME screen.

To move between menus, confirm settings and execute items, use the shift\* functions of buttons on the unit or use the cursor and ENTER buttons on the remote control.

(These explanations will primarily use remote control operations.)

\* To move the cursor, confirm settings and execute items using the unit, press the HIDE/MENU [SHIFT] button and the button with that function (shown below the button in a white rectangle with black characters) at the same time.

## Disc

This plays the disc loaded in the disc tray of the unit.

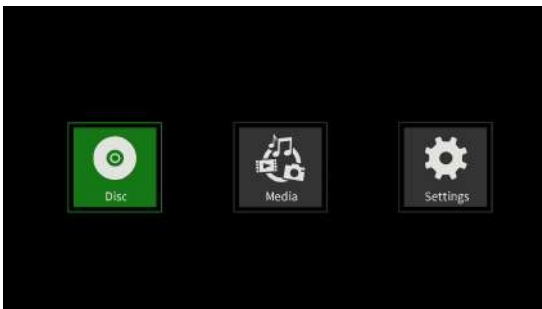

To play a disc, while the Disc icon is selected, press the ► button.

## Media

This enables selection of media (items) loaded in the unit.

### Basic remote control functions

- To exit a folder or subfolder, press the < cursor button repeatedly to return to the starting screen.
- Press the HOME button to return to the HOME screen.

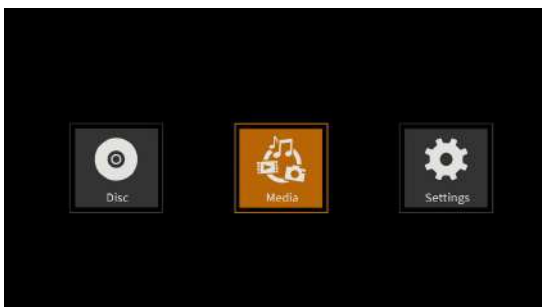

While the Media icon is selected, press the ENTER button to show the various media loaded in the unit.

### NOTE

- Usually the icons are shown in the order that the media were loaded.
- After the power is turned on, the various icons are shown in the order that the unit recognized the media. (The images shown on these pages are examples after the power was turned on.)
- BDMV icon: Blu-ray disc  
The disc loaded in the disc tray is shown as follows.



- DVD Video icon: DVD disc  
The disc loaded in the disc tray is shown as follows.



- CDDA icon: Compact disc (CD)  
The disc loaded in the disc tray is shown as follows.



Select the BDMV or CDDA icon and press the ENTER button to start playback of the media.

- SD icon: SD card
- USB1/2\* icon: USB flash drive  
Flash drives loaded in the unit are shown as follows.



\* The USB numbers show which port the USB flash drive is connected to. USB1 is connected to the front panel USB port and USB2 is connected to the rear panel USB port.

## Playing files on SD cards and USB flash drives

- Use the  $\nabla/\wedge$  cursor buttons to select an SD card or USB flash drive and press the ENTER button to show individual folders as below. (The same method is used to show the content of folders on both SD cards and USB flash drives.)



- .. : Top folder
- Photo : Photo folder
- Music : Audio folder
- Video : Video folder
- AVCHD : High-quality video folder

- Use the  $\nabla/\wedge$  cursor buttons to select a folder and press the ENTER button to show the files inside the folder. (Example: Music folder open)  
Files are shown in the order of directory entry (creation).

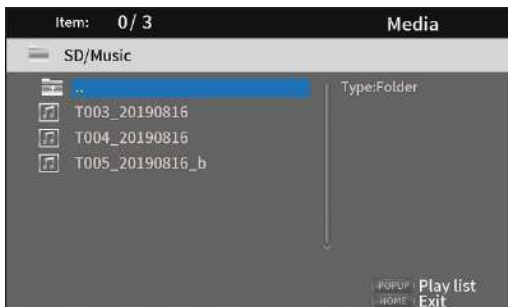

- Use the  $\nabla/\wedge$  cursor buttons to select a file and press the  $\blacktriangleright$  button to start playback.  
When a file is selected, the following information appears on the right side of the monitor.

- Thumbnails of image files
- Various information for audio and video files

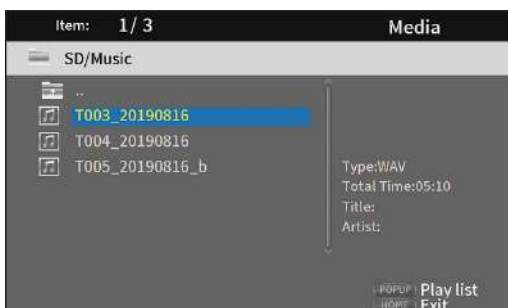

When a file is selected, press the  $\blacktriangleright$  cursor button to add a check mark before the file name, selecting it.

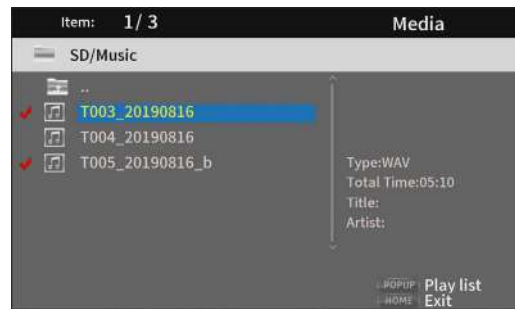

- In this state, press the ENTER button to play the selected files in order. After playback completes, the screen above will reopen.
- To remove a check mark from a file, select the file again and press the  $\blacktriangleright$  cursor button.
- Playlist icon  
By using a playlist, files can be played back in the order selected from the media (items).

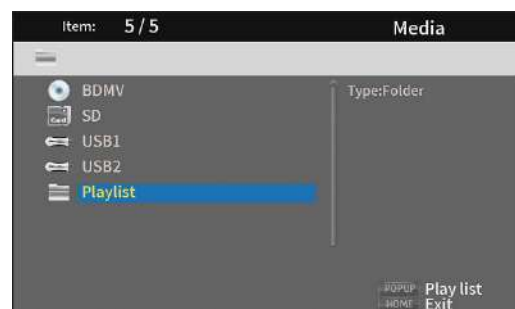

See "Playing USB flash drive/SD cards playlists" on page 31.



# Settings

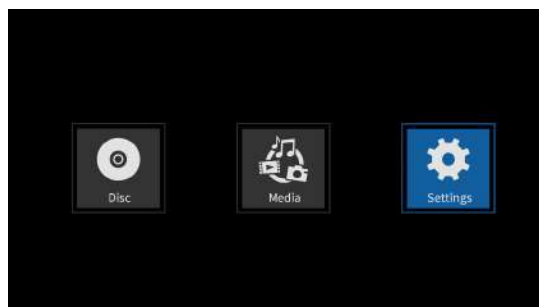

On the Settings screens, which include the General Settings, Display Settings, Audio Settings and System Information screens, settings can be made and information checked, for example.

While the Settings icon is selected, press the ENTER button to show icons for the various settings.

To move between menus, confirm settings and execute items, use the shift\* functions of buttons on the unit or use the cursor and ENTER buttons on the remote control. (These explanations will primarily use remote control operations.)

\* To move the cursor, confirm settings and execute items using the unit, press the HIDE/MENU [SHIFT] button and the button with that function (shown below the button in a white rectangle with black characters) at the same time.

## Basic remote control functions

- To exit a folder or subfolder, press the < cursor button repeatedly to return to the starting screen.
- Press the HOME button to return to the HOME screen.
- Press the RETURN button even during an operation to return to the previous screen.
- In the list of settings below, the underlined setting items are the defaults.
- Unless specifically noted, items set on Setting screens are retained even when the power is turned off.

## General Settings

### System

Function	Options	Explanation
Screen Saver	On, <u>Off</u>	Turn the screen saver on/off. If "On" is selected, the following functions become enabled when nothing is playing back or when playback is stopped or paused. <ul style="list-style-type: none"> <li>● A screensaver will appear after about 3 minutes without operation.</li> <li>● The unit will automatically turn off after about 10 minutes without operation.</li> </ul>
Remote control code	<u>RC-BDMP1MKII</u> , RC-BDMP1	In addition to the included remote control, TASCAM RC-BDMP1 remote controls (sold separately) for the BD-MP1 can also be used. <ul style="list-style-type: none"> <li>● To change the setting, the remote control to be used after the change is necessary.</li> </ul> <b>RC-BDMP1MKII</b> Select this to use an RC-BDMP1MKII. <b>RC-BDMP1</b> Select this to use an RC-BDMP1 (sold separately). <b>NOTE</b> If a remote control that is different from the current settings is selected and the ENTER button is pressed, the remote control settings screen will open. Operate the selected remote control to select OK and press the ENTER button to switch the remote control code. To cancel the change, operate the selected remote control to select "Cancel" and press the ENTER button, or wait 15 seconds without doing anything.
HDMI CEC	On, <u>Off</u>	When an HDMI cable is used to connect a device such as this unit that supports HDMI CEC to a TV that supports HDMI CEC, this function allows the remote control to link operation of both of them. (When off, only the unit will respond to the remote control.)
Disc Auto Upgrade	On, <u>Off</u>	If an upgrade disc is loaded into this unit, upgrading will occur automatically.
Load Default	More...	This function restores the various settings stored in the backup memory of the unit to their factory default values.

Function	Options	Explanation
Upgrade	Disc, USB Storage	Use to upgrade the unit firmware. (Selection of upgrade media is possible.)
Easy Setup	More...	The following settings can be made easily using a setup wizard: <ul style="list-style-type: none"> <li>Use the General Settings items to make more detailed settings, including language, monitor resolution and monitor aspect ratio.</li> </ul>
Copyrights	More...	This shows the GNU General Public License.

## Language

Function	Options	Explanation
OSD	English, Japanese	Set the language used for unit function and information screens to English or Japanese.
Disc menus*	Various languages, More...	Set the language used for option menus during playback.
Audio*	Various languages, More...	Set the language used to show during playback.
Subtitles*	Various languages, More..., Off	Set the language used to show subtitles during playback or turn subtitles off.

\* These functions only work with content that supports them.

## Playback

Function	Options	Explanation
Disc Auto Playback	On (Repeat On), On (Repeat Off), Off	Set the automatic playback (power on play) and repeat playback functions. <ul style="list-style-type: none"> <li>When the repeat function is used, playback will start automatically if the disc to be played is loaded in the disc tray and the power is turned on, as well as if a disc is changed and the disc tray is closed.</li> <li>With the repeat function, after a disc is played completely, playback will repeat continuously from the beginning. <ul style="list-style-type: none"> <li><b>On (Repeat On)</b> Both automatic and repeat playback functions are enabled.</li> <li><b>On (Repeat Off)</b> The repeat playback function is off, but the automatic playback function is enabled.</li> <li><b>Off</b> Both automatic and repeat playback functions are disabled.</li> </ul> </li> </ul> <p><b>NOTE</b></p> <ul style="list-style-type: none"> <li>This function can only be used with discs that support it. (See "Automatic playback (power-on-play) overview" on page 28 for details.)</li> <li>When the repeat function is enabled, playback will start automatically when a disc is loaded. For this reason, be careful during the following operations. <ul style="list-style-type: none"> <li>Making settings on the HOME screen</li> <li>Playing files on an SD card/USB flash drive</li> </ul> </li> <li>Automatic playback is not supported for SD cards or USB flash drives.</li> </ul>
Closed Captions	On, Off	Set whether or not the function to subtitle video disc audio is enabled.
Angle Mark	On, Off	Set whether or not an icon is shown when angle operations are available during video disc playback.
PIP Mark	On, Off	Set whether or not an icon is shown when picture-in-picture functions are available during video disc playback.
Secondary Audio Mark	On, Off	Set whether or not the secondary audio icon is shown or not.

Last Memory	On, Off	<p>Set whether or not the unit stores the last playback positions of discs in its internal memory. When this function is on, playback will start from the stored position when a disc is played again.</p> <p><b>NOTE</b></p> <ul style="list-style-type: none"> <li>• These functions only work with content that support them.</li> <li>• Pressing the HOME button during playback will not save the playback position.</li> <li>• This unit can save positions for five discs maximum. When the total number of discs would exceed five, the record for the disc played least recently will be replaced by a record for the most recent disc.</li> </ul>
-------------	---------	-------------------------------------------------------------------------------------------------------------------------------------------------------------------------------------------------------------------------------------------------------------------------------------------------------------------------------------------------------------------------------------------------------------------------------------------------------------------------------------------------------------------------------------------------------------------------------------------------------------------------------------------------------------

## Security

Function	Options	Explanation
Change Password	More...	<p>A password can be set for the unit. The password is a 4-digit number.</p> <ul style="list-style-type: none"> <li>• The default password is "0000".</li> </ul>
Parental Control	More...	<p>Set the age rating restriction for discs. A password must be input to change this.</p> <ul style="list-style-type: none"> <li>• The default setting is "Off".</li> </ul>
Country Code	More...	<p>Set the country to use for Parental Control. A password must be input to change this.</p>

## Network

Function	Options	Explanation
Internet Connection	Enable, Disable	Enable or disable Internet connection for the unit.
Interface	Ethernet, Wireless	<p>Set the method of Internet access for the unit to "Ethernet" or "Wireless".*</p> <p><b>NOTE</b></p> <p>Operation is not guaranteed in wireless mode.</p> <p>When using "Wireless", after responding "Yes", select from the following connection methods.</p> <p><b>Scan</b></p> <p>The unit will search for access points, allowing selection of a network.</p> <p><b>Manual</b></p> <p>An SSID can be set manually to connect.</p> <p><b>Auto</b></p> <p>Connection is possible using Wi-Fi Protected Setup (WPS) standards.</p>
Information	More...	<p>The following information related to the Internet connection is shown:</p> <p>interface, address type, IP address, subnet mask, gateway, DNS1 and DNS2.</p>
Connection Test	More...	This tests the network connection.
IP Setting	Auto, Manual	<p>Select how the unit's IP address is set.</p> <p><b>Auto</b></p> <p>Automatically acquire the IP address from a DHCP server.</p> <p><b>Manual</b></p> <p>Manually input the interface, address type, IP address, subnet mask, gateway, DNS1 and DNS2 numbers.</p>

Function	Options	Explanation
Wireless Setting	More...	Use this to make wireless connection settings.* <b>Scan</b> The unit will search for access points, allowing selection of a network. <b>Manual</b> An SSID can be set manually to connect. <b>Auto</b> Connection is possible using Wi-Fi Protected Setup (WPS) standards.
BD-Live BUDA	BUDA Information, BUDA Setup	Set the storage location used to save BD-Live contents. <b>BUDA Information</b> This shows the amount of open space in the storage location used to save content. Press the ENTER button to show the "Fmt buda" button, and press the ENTER button again. This creates a BUDA folder in the selected storage location. <b>BUDA Setup</b> The storage location used by BUDA can be set to an external device or the internal storage. External : A USB flash drive connected to the unit will be used.** Onboard : The internal storage of the device will be used.
BD-LIVE Connection	Permitted, Partially Permitted, Prohibited	Select the access level for BD-Live contents on the Internet. <b>Permitted</b> All contents can be accessed. <b>Partially Permitted</b> Specific contents can be accessed. <b>Prohibited</b> BD-Live contents will be blocked.
Proxy Settings	Disable, Enable	Set whether or not to connect this unit to the Internet through a proxy server. <b>Disable</b> Do not use a proxy server. <b>Enable</b> A proxy host and proxy port can be set.

\* "Wireless" connection can only be used if a USB-wireless LAN adapter has been connected to the unit.

A USB-wireless LAN adapter is not included with this unit. Wireless LAN adapters can be used, but operation is not guaranteed because acquisition of applicable products is difficult.

\*\* If USB flash drives have been connected to both the front and back USB ports, the one first recognized by the unit will be used for external memory.

## Display Settings

### TV

Function	Options	Explanation
TV Screen	16:9 Full, 16:9 Normal, 4:3 Pan & Scan, 4:3 Letterbox	Use to set the display aspect ratio. <ul style="list-style-type: none"> <li>● 16:9 Full: Always make the aspect ratio 16:9. 4:3 video will also be made 16:9.</li> <li>● 16:9 Normal: Usually make the aspect ratio 16:9. 4:3 video will be shown with black bands on the left and right sides.</li> <li>● 4:3 Pan &amp; Scan: Always make the aspect ratio 4:3. 16:9 video will also be made 4:3.</li> <li>● 4:3 Letterbox: Usually make the aspect ratio 4:3. 16:9 video will be shown with black bands on the top and bottom.</li> </ul>
Resolution	Auto, 480i/576i, 480p/576p, 720p, 1080i, 1080p	Use to set the image resolution. <ul style="list-style-type: none"> <li>● If Auto is selected, this unit will detect the optimal resolution for the monitor or TV. In this case, a message confirming the saving of the selection will appear. Select "OK" as necessary.</li> <li>● When a setting value is changed, a confirmation to approve saving will appear. Press OK to retain the setting.</li> </ul>
TV System	NTSC, PAL, Multi	Select the broadcast format* of the device connected to the unit.

Color Space	<u>RGB</u> , YCbCr, YCbCr422, Full RGB	Select the HDMI output color space.
HDMI Deep Color	30 bits, 36 bits, 48 bits, <u>Off</u>	Select the HDMI output deep color mode.**
HDMI 1080P 24Hz	On, <u>Off</u>	Turn frame rate conversion on/off for 1080P Blu-ray discs that play back at 24 Hz.
HDMI 3D	<u>Auto</u> , Off	When Auto is selected, the 3D signal will automatically be output when 3D video is played. When Off is selected, 3D signals will not be output.

\* When in a region that supports both NTSC and PAL, select "Multi".

\*\* For this function to work properly, the TV or monitor must support HDMI version 1.3 or later.

## Video Process

Function	Options	Explanation
Video Adjustments	More...	Adjust the brightness, contrast, hue and saturation output from this unit to the TV or monitor. Brightness, Contrast, Hue, Saturation
Sharpness	High, Normal, <u>Low</u>	Set the sharpness to High/Normal/Low for images output from this unit to the TV or monitor.

## Closed Captions

Function	Options	Explanation
CC Attributes	<u>Auto</u> , Custom	<b>Auto</b> Use default attributes for subtitle fonts and windows, including their size, color and opacity. <b>Custom</b> Enable adjustment of subtitle fonts and windows, including their size, color and opacity.
Font color	Default, <u>White</u> , Black, Red, Green, Blue, Yellow, Magenta, Cyan	The color of subtitle fonts can be adjusted.
Font size	Default, <u>Standard</u> , Small, Large	The size of subtitle fonts can be adjusted.
Font style	<u>Default</u> , Monospaced with serifs, Proportionally spaced with serifs, Monospaced without serifs, Proportionally spaced without serifs	The style of subtitle fonts can be adjusted.
Font opacity	<u>Solid</u> , Translucent, Transparent	The opacity of subtitle fonts can be adjusted. Solid Translucent Transparent
Font edge	Default, <u>None</u> , Raised, Depressed Uniform, Left drop shadow, Right drop shadow	An edge effect can be added to subtitle fonts. Raised Depressed Uniform Left drop shadow Right drop shadow
Font edge color	<u>White</u> , Black, Red, Green, Blue, Yellow, Magenta, Cyan	The edges of subtitle fonts can have a color added.
Background color	Default, White, <u>Black</u> , Red, Green, Blue, Yellow, Magenta, Cyan	The background color of subtitle fonts can be changed.
Background opacity	<u>Solid</u> , Translucent, Transparent	The opacity of the background of subtitle fonts can be changed. Solid Translucent Transparent
Window color	Default, White, Black, <u>Red</u> , Green, Blue, Yellow, Magenta, Cyan	The color of the subtitle window can be changed.
Window opacity	<u>Solid</u> , Translucent, Transparent	The opacity of the subtitle window can be changed. Solid Translucent Transparent

## Audio Settings

### Audio Output

Function	Options	Explanation
S/PDIF	Bitstream, <u>PCM</u> , Off	This selects the digital audio signal format. * <ul style="list-style-type: none"> <li>When set to Bitstream, a maximum of 6 channels (5.1) of digital audio can be output. Dolby TrueHD and other 7.1ch formats are not supported. When set to PCM, the 2 channels of audio specified in the S/PDIF Output Configuration settings will be output.</li> </ul>
HDMI	<u>Bitstream</u> , PCM, Off	This selects the HDMI audio format. <ul style="list-style-type: none"> <li>When set to Bitstream, audio will be output without decoding. Dolby Atmos and other formats with more than 7.1 channels can be output. When set to PCM, Dolby TrueHD and other formats with up to 7.1 channels can be output.</li> </ul>
FS Setting	48 kHz, 96 kHz, 192 kHz	The sampling frequency can be selected.** <ul style="list-style-type: none"> <li>This is not applied to HDMI output.</li> </ul>
Volume Control	<u>Enable</u> , Disable	Volume up/down operations can be enabled or disabled.
Dolby DRC	Off, On, <u>Auto</u>	Set the dynamic range to Off, On or Auto.

\* Select Bitstream when using for surround sound connected to an AV amplifier, for example. In order to use bitstream, the connected device must support it.

\*\* This selects the downsampling frequency used for signal processing inside the unit during audio playback. If an audio signal is played that has a sampling frequency higher than the selected value, it will be converted to the set sampling frequency. PCM signals output from the DIGITAL OUT connector will also be downsampled to the set value.

### Speaker Settings

Function	Options	Explanation									
Configuration	2.x, 3.x, 4.x, 5.x, 6.x, <u>7.x</u>	The channel configuration can be selected. The speaker size can be set, and the trim and delay can be adjusted for each channel. The trim can be adjusted in a range from -10 dB to +10 dB in 0.5dB increments. ** The delay can be adjusted in a range from 0 cm to 1000 cm in 5cm increments. The delay time is 29μsec/cm. <table border="1" style="width: 100%; border-collapse: collapse;"> <thead> <tr> <th>Configuration</th> <th>Subwoofer selection</th> </tr> </thead> <tbody> <tr> <td>2.x: Lt/Rt*, Stereo</td> <td rowspan="7" style="text-align: center; vertical-align: middle;">None, Single</td> </tr> <tr> <td>3.x: LCR</td> </tr> <tr> <td>4.x: LRLsRs</td> </tr> <tr> <td>5.x: -</td> </tr> <tr> <td>6.x: -</td> </tr> <tr> <td>7.x: C+LR+LsRs+LsrRsr</td> </tr> </tbody> </table>	Configuration	Subwoofer selection	2.x: Lt/Rt*, Stereo	None, Single	3.x: LCR	4.x: LRLsRs	5.x: -	6.x: -	7.x: C+LR+LsRs+LsrRsr
Configuration	Subwoofer selection										
2.x: Lt/Rt*, Stereo	None, Single										
3.x: LCR											
4.x: LRLsRs											
5.x: -											
6.x: -											
7.x: C+LR+LsRs+LsrRsr											
Test Tone		More...	The speaker size can be set, and the trim and delay can be adjusted while outputting a test tone from the speaker. **								

\* Lt/Rt is a two-channel downmix output that supports Dolby surround. When played on an ordinary stereo system, the L and R channel balance could be degraded. If this occurs, select Stereo.

\*\* Trim adjustment overview

Digital full scale (-10dB) is shown as "0" to make adjustment of surround channel speaker volume differences easier.

If trim adjustment is unnecessary, use the default setting (+10).

- When the channel configuration is not 2.x, FL/FR audio signals are output from the ANALOG OUT jacks.

### S/PDIF Output Configuration

Function	Options	Explanation
Configuration	FL/FR, SL/SR, C/SW, SBL/SBR, L/R (-10dBFS)*	The selection items are the same signals that are output from the analog outputs on the back of the unit. The selected analog outputs are output from the digital audio output (COAXIAL) connector. <ul style="list-style-type: none"> <li>This setting applies when using PCM. The S/PDIF setting has no effect when using Bitstream.</li> </ul>

\* The maximum audio level will become -10 dBFS only for L/R

## System Information

Use this to check the model name with region code, the MAC address and the firmware revision of the unit.

Model : BD-MP1MKII(XX)  
MAC address : xx-xx-xx-xx-xx-xx  
Revision : xx.xx

# Making connections

This is an example of connections with the unit.

## Precautions before making connections

- Carefully read the operation manuals of the devices to be connected and then connect them correctly.
- Before making connections, turn this unit and all equipment to be connected off (standby).
- Install all connected devices, including this unit, so that they are powered from the same line. When using a power strip or similar device, be sure to use one that has high current capacity (thick cable) in order to minimize fluctuations in power voltage. Moreover, do not bundle or wrap power cords.
- Connect cable types correctly. (Be careful not to insert cables into the wrong connectors or with the wrong orientation.)
- This unit has been designed with the assumption that it will be used connected by HDMI to a TV or monitor. When using it, please connect it by HDMI to a TV or monitor.

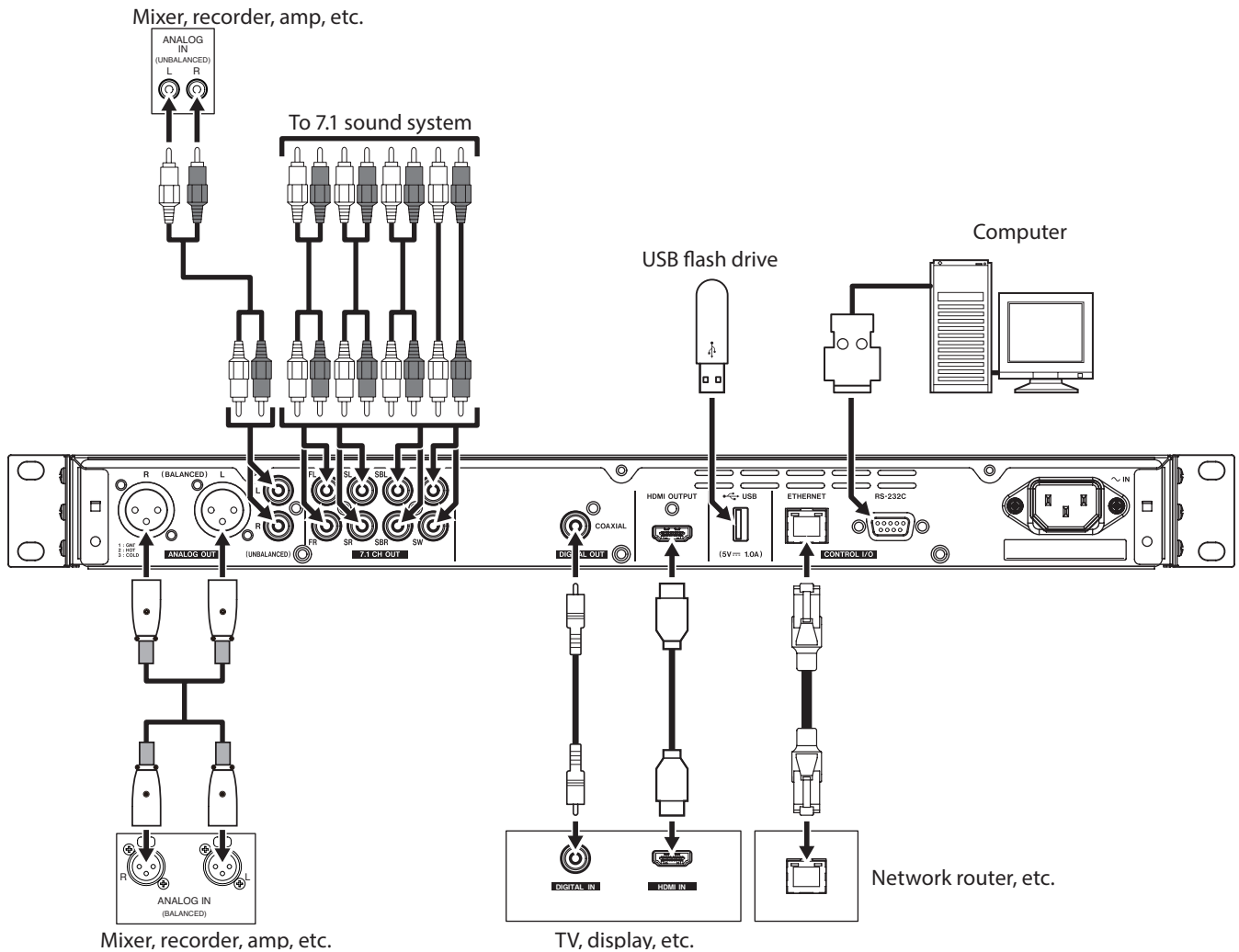

## Installing rackmount ears

The included rackmount ears must first be attached before mounting this unit in a rack.

- Refer to the illustration below when attaching them.

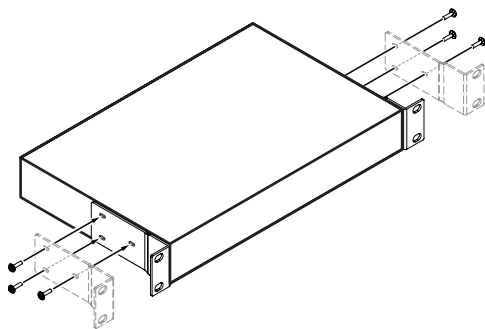

### NOTE

- A Phillips screwdriver is necessary for attachment.
- The attachment holes in the included rackmount ears are elongated, allowing adjustment so that the unit does not stick out of the rack when attached.



# Display

## Normal state

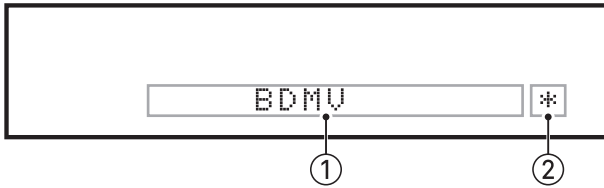

### ① Various information

- When the HOME screen is open, this shows the type of disc loaded in the disc tray.

Blu-ray disc	<b>BDMV, BDAV</b>
DVD	<b>DVD, DVR</b>
Audio CD	<b>CD</b>
Data disc	<b>DATA</b>
AVCHD disc	<b>AVCHD</b>
Unknown disc type	<b>UNK DISC</b>
No disc loaded	<b>NO DISC</b>

- When the Media page of the HOME Screen is open, this shows the currently selected file or folder item order (5-digit).
- "SETUP" appears when on the Settings page of the HOME screen.
- Various information is shown in response to different operations.

When a USB flash drive is connected	<b>USB IN</b>
When a USB flash drive is disconnected	<b>USB OUT</b>
When the STOP button is pressed	<b>STOP</b>
When the TITLE/POP UP button is pressed	<b>POP</b>
When the disc tray is open	<b>OPEN</b>
When the disc tray is closed	<b>CLOSE</b>
When a medium is recognized	<b>LOAD</b>

- Other information shown
 

When the title menu of a disc that contains multiple titles is open	<b>ROOT</b>
When the title menu of a purchased or rental video disc is open	<b>TOP</b>
During a firmware update	<b>UPGRADE</b>
Volume adjustment	<b>VOLxx</b>

 xx is a set value within the adjustment range (minimum -41 to maximum 0)

### ② HIDE MENU indicator

When the HIDE MENU function is on, an \* will be shown.

#### NOTE

If the screen is black or the Settings screen does not open when the SETUP button on the remote control is pressed, check whether this indicator (\*) is being shown, and turn the HIDE MENU function off if necessary.

## During playback

During playback, this shows the playback status and the current title, chapter and time.

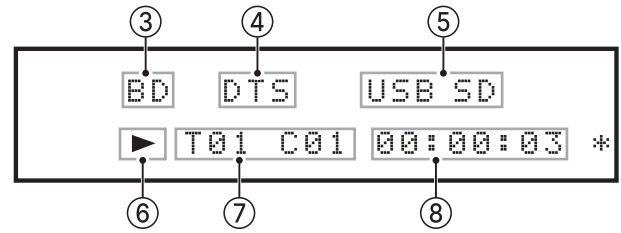

### ③ Type of disc in tray

During playback, this shows the type of disc.

Blu-ray disc	<b>BD</b>
DVD	<b>DVD</b>
Audio CD	<b>CD</b>
Data disc	<b>DISC</b>

### ④ Audio output info

"DTS" appears during DTS, DTSHD and other DTS surround playback. "DB" appears during Dolby digital and other Dolby playback.

### ⑤ Connected media

USB appears when a file is playing on a USB flash drive or other device connected to a USB port. SD appears when a file is playing on an SD card loaded in the SD card slot. "USB" or "SD" will also appear when USB or SD is selected on the Media Screen.

### ⑥ Media operation status

When the unit is playing or paused, an icon appears here.

Playing	<b>▶</b>
Playback paused	<b>  </b>

### ⑦ Media title, chapter and track

When the unit is playing or paused, title, chapter and track information appears here.

Title/track	<b>T00 C00</b>
Chapter	<b>C00</b>

### ⑧ Playback time

This shows the current playback time. This is shown in the format selected in the information bar. To switch the time shown on the unit display, switch the ON SCREEN time setting. (See "Overview of ON SCREEN information bar" on page 35.)

---

## Preparing the remote control

---

### Installing batteries

1. Open the cover on the back.
2. Insert two AAA batteries, being certain to use the correct ⊕ and ⊖ orientations.
3. Close the cover.

### When to replace batteries

Replace both batteries with new ones if the distance from the main unit that the remote can be used decreases or if the unit stops responding to the remote buttons.

### Battery precautions

Misuse of batteries could cause them to leak or rupture, for example. Carefully read and follow the battery caution labels. (see “CAUTIONS ABOUT BATTERIES” on page 6)

### Using the wireless remote control

See “Wireless remote control (TASCAM RC-BDMP1MKII)” on page 13 for the button functions.

When using the remote control, point it toward the receiver on the unit and use it within the range shown below.

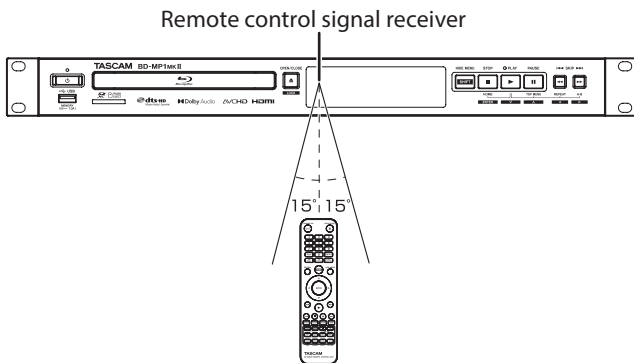

**Remote control operation range**  
From any angle within 15° of front: 5 m

#### ATTENTION

- Operation might not be possible if there are obstacles.
- Remove the battery if not using the remote control for a long time (a month or more).
- If battery fluid should leak, wipe away any fluid inside the case thoroughly and install a new battery.
- When using other devices that can be controlled by infrared rays, operation of this remote control could cause those devices to function improperly.

---

## Turning the unit on and putting it into standby

---

#### NOTE

When this unit is connected by a power cord and electricity is supplied from an outlet, it will automatically start up. (This will also occur when power is restored after a power outage or other interruption to the power supply.)

### Turning the unit on

If the STANDBY/ON indicator on the front of the unit lights red, press the  button or the remote control STANDBY/ON button.



Startup screen



Operation screen

After the unit starts and the startup screen is shown, the operation screen will appear on the display.

### Putting the unit into standby

Press the  button on the front of the unit or the remote control STANDBY/ON button to put the unit into standby.

#### ATTENTION

Do not turn the power off or disconnect the power cord when the unit is operating (including playing back or writing data to a USB flash drive). Doing so could damage the unit.

---

## Loading and removing discs

---

### Loading discs

Press the OPEN/CLOSE () button on the main unit or remote control.

Open the disc tray and place the disc on it with the label side up. Press the OPEN/CLOSE () button again to close the disc tray.

After loading a disc, the unit will read its information and show the media type on the display.

#### NOTE

When the disc tray is open, “OPEN” will appear on the display.  
When the disc tray is open, “CLOSE” will appear on the display.

### Ejecting discs

Press the OPEN/CLOSE () button on the main unit or remote control.

After the disc tray opens, pick the disc up by its center and remove it.

#### NOTE

The OPEN/CLOSE () button functions when the unit is turned on.

---

## Inserting and removing SD cards

---

### Inserting SD cards

Insert an SD card into the SD card slot on the front of the unit to enable playback.

#### TIP

- SD cards can be inserted whether or not the unit is on or off.
- Inserted SD cards with the correct orientation.
  - The label should be up and the connector should be inserted toward the back.

---

### Removing SD cards

Turn the unit off or stop operation before removing an SD card.

#### CAUTION

Do not remove an SD card when the unit is operating (playing back an SD card). Doing so could cause proper dubbing to fail, data to be lost, and sudden loud noises from monitoring equipment, which might damage the equipment, harm hearing or cause other trouble.

1. Press the SD card in gently to make it to come forward.
2. Pull the SD card out by hand.

---

### SD card write protection switches

SD cards have write-protection switches that prevent writing new data to them.

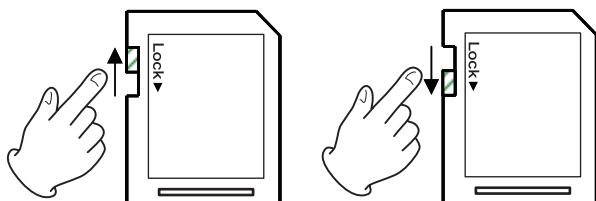

---

## Connecting and disconnecting USB flash drives

---

### Connecting USB flash drives

Connect a USB flash drive to the USB port on the front or back of the unit to enable playback.

#### TIP

You can connect a USB flash drive when the unit is on or off.

---

### Disconnecting USB flash drives

Turn the unit off or stop operation before disconnecting a USB flash drive.

#### ATTENTION

Never disconnect a USB flash drive when the unit is operating (including playing back or writing data to the USB flash drive). Doing so could cause the loss of data or damage the unit.

---

## Lock functions

---

By using the lock functions, opening and closing the disc tray, and operations using the remote control and main unit buttons can be locked.

1. Press the HIDE MENU [SHIFT] and OPEN/CLOSE [LOCK] buttons on the front of the unit at the same time. The current lock status will appear on the unit display.
2. While pressing and holding the HIDE MENU [SHIFT] button on the unit, press the OPEN/CLOSE [LOCK] button again.
  - Pressing these buttons changes the status every time.
  - Press the OPEN/CLOSE [LOCK] button while continuing to press and hold the HIDE MENU [SHIFT] button until the desired lock function appears.

Unit display indication	Lock status
LOCK: T LOCK	Disc tray locked
LOCK: P LOCK	Main unit buttons locked*
LOCK: R LOCK	Remote control locked
LOCK: R+P LOCK	Remote control and main unit buttons locked*
LOCK: R+T LOCK	Remote control and disc tray locked
LOCK: OFF	Unlocked

\* Even when the main unit buttons are locked, pressing the HIDE MENU [SHIFT] and OPEN/CLOSE [LOCK] buttons at the same time still works.

---

### When locked

If operation of the front panel is attempted when the front panel is locked, "LOCKED" will appear on the display and that operation will not be executed.

#### NOTE

Turning the power on again is possible even if the unit is locked and in standby. The unit will remain locked after it starts up.

---

## Remote control overview

---

This unit can be controlled remotely by connecting it to a computer, either by connecting their RS-232C ports with an RS-232C cable or by connecting the unit's ETHERNET to a LAN port on the computer with a LAN cable.

- For details about this unit's communication and command protocols for ETHERNET and RS-232C, refer to the BD-MP1MKII download page on the TASCAM website.

<https://tascam.jp/int/product/bd-mp1mkii/docs>

---

## BD-Live overview

---

This unit supports BD-Video (BD-ROM Profile 2.0) with BD-Live functions.

By connecting this unit to the Internet, this function can be used to enable additional content, including special videos and subtitles.

- The various functions that can be used with BD-Live depend on the disc. Refer to the screen display and explanations of the disc for details about those functions and operations.
- To use BD-Live functions, connect this unit to the Internet and make the necessary settings. To use BD-Live functions, connect this unit to the Internet and make the necessary settings. See "Network connection overview" on page 38 for connection procedures, and "Network" on page 19 for setting procedures.
- Depending on the disc, changing the settings described in "Network" on page 19 might be necessary.
- If the BD-LIVE Connection setting is "Prohibited" in "Network" on page 19, BD-Live content will not be able to access the Internet.
- Depending on the network setup being used, network connection might take some time or might not even be possible.
- During playback of discs that support BD-Live, identification data for the unit or disc might be transmitted to the content provider. To limit Internet connection, change the settings for "Network" on page 19.

---

## Types of media that can be played

---

This unit can play the following media formats.

### Disc media

- Supported Blu-ray  
BD25, BD50, BD-ROM, BD-R(SL, DL), BD-RE(SL, DL)
- Supported DVD  
DVD-ROM, DVD+R(SL, DL), DVD-R(SL, DL), DVD+RW, DVD-RW
- Supported CD  
CD-DA, CD-R, CD-RW

### NOTE

SL indicates single-layer discs and DL indicates double-layer discs

### Disc formats

- Supported Blu-ray  
BDMV, BDAV
- Supported DVD  
DVD-Video, DVD-VR, AVCHD

### NOTE

- BD-R/DVD-RW/DVD-R media that have not been finalized (closed) might not play properly.
- BD-RE version 1.0 (cartridge type) and DVD-RAM media cannot be played.
- Additional recorded parts cannot be played from BD-RE/BD-R/DVD-RW/DVD-R media with multi-session (multi-border) recordings.
- Some BD-Video/DVD-Video media might not operate as explained in this manual due to the intentions of their producers. For details, refer to the manuals of such discs.
- Use music CDs that conform to ISO standards.
- Playback is not guaranteed for all discs that conform to the standards.
- Blu-ray 3D is supported. To watch Blu-ray 3D media, use a High Speed HDMI cable to connect this unit to a device that supports 3D.

---

## Playable file formats (video, audio and image)

---

This unit can play the following file formats.

### Video formats

.asf, .mpg, .avi, .3gp, .dat, .mkv, .mov, .m2ts, .ogm, .tp, .ts, .mp4, .wmv

### Audio formats

.wav, .mp3, .wma, .aac, .flac, .ape

### Still image formats

.jpeg, .gif, .png

### NOTE

USB flash drives and SD cards must use FAT16, FAT32, exFAT or NTFS file systems.

---

## Playing media

---

This section explains basic operations, including playback, pausing and stopping.

The following explanations assume that necessary connections have been completed, the unit is on, a disc or other media that contains video or audio files has been loaded, the current source has been selected, and "BDMV", "BDAV", "DVD", "CD", "USB" or "SD", for example, appears on the display.

---

## Loading discs

---

Conduct the following operations with the buttons on the front of the unit or with the remote control.

(These explanations will primarily use remote control operations.)

1. Press the OPEN/CLOSE ( $\blacktriangle$ ) button to open the disc tray.
2. Load a disc in the disc tray, and press the OPEN/CLOSE ( $\blacktriangle$ ) button again to close it.

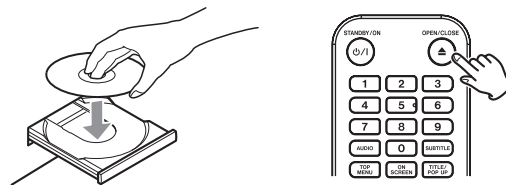

While the disc is being read, "LOAD" appears on the display, followed by one of the items below when reading completes.

Blu-ray disc: **BDMV, BDAV**

DVD: **DVD**

Audio CD: **CD**

---

## Automatic playback (power-on-play) overview

---

When Disc Auto Playback (HOME screen > Settings > System) is set to On (Repeat On) (the default is Off), discs will start playing automatically after they are loaded.

When Disc Auto Playback is Off or playback does not start, select Disc on the HOME screen, and press the ENTER or  $\blacktriangleright$  button.

Automatic playback (power-on-play) behavior differs according to the disc.

- Repeat playback after automatic playback  
Set Disc Auto Playback to On (Repeat On).  
Repeat playback after automatic playback is only possible with DVD-VIDEO discs.
- Automatic playback only (no repeat playback)  
Set Disc Auto Playback to On (Repeat Off).  
Discs that support only automatic playback include Blu-ray (BDMV), DVD-VIDEO, AVCHD, VCD2.0 and CD-DA (music CD) discs that do not have disc menus.

## NOTE

- When the repeat function is enabled, playback will start automatically when a disc is loaded. For this reason, be careful during the following operations.
  - Making settings on the HOME screen
  - Playing files on an SD card/USB flash drive
- Automatic playback is not supported for SD cards or USB flash drives.

## Playing video discs

- If a disc that has never been played before is loaded, it will start playing from the beginning.
- If Last Memory (HOME screen > Settings > System) is set to On (the default is On), when discs that have been played before are loaded, they will resume playing\* from the position where they were last stopped.

\* This only works with purchased or rental video discs. Moreover, the unit can save positions for five discs maximum with this function. When the total number of discs would exceed five, the record for the disc played least recently will be replaced by a record for the most recent disc.

## Operating from disc top menus and pop-up menus

When video discs have menus or pop-up menus, they can be shown and a variety of operations are possible. (The contents of menus and pop-up menus depend on the programming of the discs.)

- To show the title menu, press the TOP MENU button. If this is done when playing or paused, playback will stop.  
To show the title menu without stopping playback when playing or paused, press the TITLE/POP UP button.  
To move between items in the title menu use the cursor buttons, and press the ENTER button to confirm.

## Pausing playback

To pause playback, press the **II** button.  
Press the **II** button again or press the **▶** button to resume playback from the stopped position.

## Stopping playback

To stop playback, press the **■** button.  
Press the **▶** or ENTER button to start playback from the stopped position.

## NOTE

- Unlike when paused, whatever is shown on the monitor will disappear.
- During repeat playback, the repeat mode will be cleared.

## Searching backward/forward

Use the **◀◀/▶▶** buttons to search backward/forward.  
Pressing the **◀◀/▶▶** button again will change the search speed up to five levels.  
Pressing it again will return to ordinary playback.  
When searching backward/forward in a disc, press the **II** button to pause playback.  
Pressing the **II** button again will resume playback.

## Skipping to the previous or next chapter/track

Press the **◀◀/▶▶** button to skip to the previous/next chapter/track.

- When playing, paused or searching backward/forward, press the **◀◀/▶▶** button to skip to the previous/next chapter/track and resume playback.
- To return to the beginning of the currently playing chapter/track, press the **.** button once.  
(However, if the current chapter/track is playing back or paused within a few seconds of its beginning, this will move to the previous chapter/track and resume playback.)

## Repeating playback of part of a scene or track

During media playback, press the A-B button to set a desired interval (between A and B points) and play it back repeatedly. (In this explanation, "scene" is used, but it also applies to "tracks" when using audio files.)

## NOTE

- This repeat playback function is different from the automatic playback repeat function.
- The repeat playback function will be disabled if the power is turned off, playback is stopped or the HOME screen is reopened.

1. Press the A-B button at the point in the scene where repeat playback will start. The starting point "A-" will appear at the top of the monitor.
2. Next, press the A-B button at the point in the scene where repeat playback will end. The starting and ending points "A-B" will appear at the top of the monitor, and repeat playback will continue between these points.
3. During repeat playback, press the A-B button again to end repeat playback and continue ordinary playback.  
(Not all video discs support this function.)



## Repeating playback of a chapter, title or track

Press the REPEAT button to enable repeat playback mode. The currently playing chapter, title or track will play repeatedly. Press this button repeatedly to change the repeat playback mode.



## NOTE

- This repeat playback function is different from the automatic playback repeat function.
- The repeat playback function will be disabled if the power is turned off, playback is stopped or the HOME screen is reopened.

## Video discs

- During chapter repeat playback, playback starts at the beginning of the current chapter. (The  icon appears at the top of the monitor.)
- During title repeat playback, playback starts at the beginning of the current title. (The  icon appears at the top of the monitor.)
- During all repeat playback, playback starts at the beginning of the video file. (The  icon appears at the top of the monitor.)

## CDs and video/audio files

- During single repeat playback, playback starts at the beginning of the current track. (The  icon appears at the top of the monitor.)
- During all repeat playback, playback repeats for all tracks on a CD and for all video/audio files in the same folder. (The  icon appears at the top of the monitor.)

## Jumping to a specific playback time, scene or track

(This also applies to “chapters” when using audio discs.)  
 During disc playback, press the SEARCH button to show an information bar at the top of the monitor. A cursor will appear in the time display area.



At this time, press a  $\langle / \rangle$  cursor button to move the selection between the time and chapter display areas.



### NOTE

Only playback times and chapter numbers that exist on the playing disc can be specified. Values that exceed these ranges cannot be specified.

## Jumping to a specific playback time

1. During disc playback, press the SEARCH button to show an information bar at the top of the monitor. A cursor will appear in the time display area.
2. In this state, press the ENTER button to select the time display area, enabling the value to be changed.



3. Use the number buttons to input values. Use the  $\langle / \rangle$  cursor buttons to move between the hours, minutes and seconds. (In the illustration below, values have been entered for minutes and seconds.)



4. After inputting values, press the ENTER button to start playback from the specified time. (The chapter display will also change to the chapter at the specified time.)

**Chapter display**                      **Time display**  
 Hours: minutes: seconds



- Press the ON SCREEN button to close the information bar.

## Jumping to a specific chapter or track

1. Use a  $\langle / \rangle$  cursor button in the time display area to move the cursor to the chapter display area. In this state, press the ENTER button to show up and down triangle icons in the chapter display area, enabling the value to be changed.



2. Use the number buttons to input values.
3. After inputting values, press the ENTER button to start playback from the specified chapter. (The time display will also change to the time at the specified chapter.) Press the ON SCREEN button to close the information bar.

## Playing USB flash drives and SD cards

To play these with the unit, connect them to a USB port or SD card slot.

### NOTE

There are USB ports on both the front and the back of the unit.

While the medium is being read, “LOAD” appears on the display, followed by one of the items below when reading completes.

USB flash drive : USB  
 SD card : SD

1. Select Media on the HOME screen and press the ENTER button. Media icons will appear. Use the  $\vee / \wedge$  cursor buttons to select an SD/USB icon and press the ENTER button.

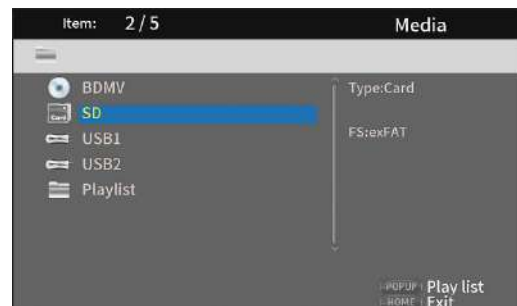

2. Opening the selected icon will show the following folders.



 .. : Top folder  
 Photo : Photo folder  
 Music : Audio folder  
 Video : Video folder  
 AVCHD : High-quality video folder

3. Select the target folder, and press the ENTER button. Files inside the folder will be shown. (Example: Music folder open)

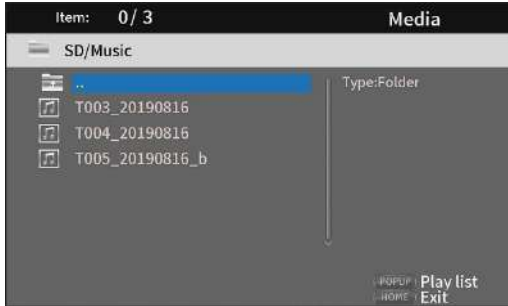

4. Use the  $\nabla/\wedge$  cursor buttons to select a file and press the  $\blacktriangleright$  button to start playback. When a file is selected, the following information appears on the right side of the monitor.
  - Thumbnails of image files
  - Various information for audio and video files

## Playing USB flash drive/SD cards playlists

To play these with the unit, connect them to a USB port or SD card slot.

### NOTE

There are USB ports on both the front and the back of the unit.

While the medium is being read, "LOAD" appears on the display, followed by one of the items below when reading completes.

USB flash drive : USB  
SD card: : SD

### NOTE

- Media files in playlists will be played back in the order that they were selected.
- If media is disconnected, files on that media will be removed from the playlist.
- Turning off the power will erase the playlist.

## Adding files to a playlist

1. Select Media on the HOME screen and press the ENTER button. Media icons will appear. Use the  $\nabla/\wedge$  cursor buttons to select an SD/USB icon and press the ENTER button.

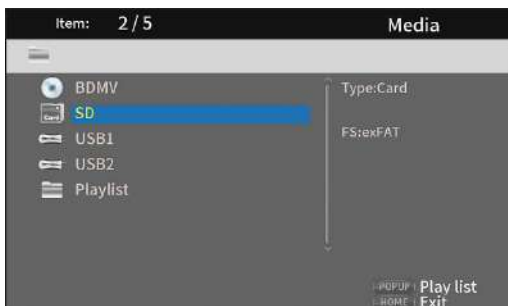

2. Opening the selected icon will show the following folders.

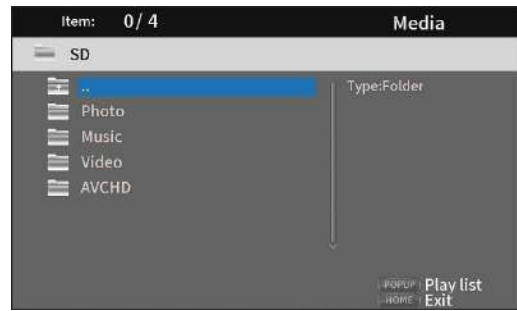

- $\square$ .. : Top folder
- Photo : Photo folder
- Music : Audio folder
- Video : Video folder
- AVCHD : High-quality video folder

### NOTE

Playlists can only include image, audio or video files. A playlist cannot contain different types of files. (For example, it cannot contain both image and video files.)

3. Select the file to add to the playlist, and press the TITLE/POP UP button to open a pop-up message.



4. Use the  $\nabla/\wedge$  cursor buttons to select "Add to Playlist", and press the ENTER button to add the selected file to the playlist.
  - When a file is selected, press the  $\blacktriangleright$  cursor button to add a check mark before the file name, selecting it.

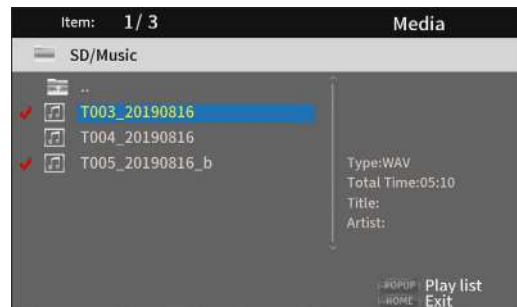

Select a file again and press the  $\blacktriangleright$  cursor button to remove its check mark.

- Add check marks to the necessary files, and press the TITLE/POP UP button to open a pop-up message. Use the  $\nabla/\wedge$  cursor buttons to select "Add to Playlist", and press the ENTER button to add the selected file to the playlist.



- In addition, check marks can be added to all files in the folder by selecting "Select all" in the pop-up and pressing the ENTER button in step 3.



- With check marks added to files, press the TITLE/POP UP button to open a pop-up message. Use the  $\nabla/\wedge$  cursor buttons to select "Add to Playlist", and press the ENTER button to add the selected file to the playlist.
- Select "Clear all" in the pop-up message and press the ENTER button to remove check marks from all files. Exiting the folder will also remove the check marks from all files. To do nothing, select "Cancel" and press the ENTER button, or press the RETURN button to return to the original screen.

## Playing files in a playlist

1. Select Media on the HOME screen and press the ENTER button. Media icons will appear. Use the  $\nabla/\wedge$  cursor buttons to select the Playlist folder and press the ENTER button.

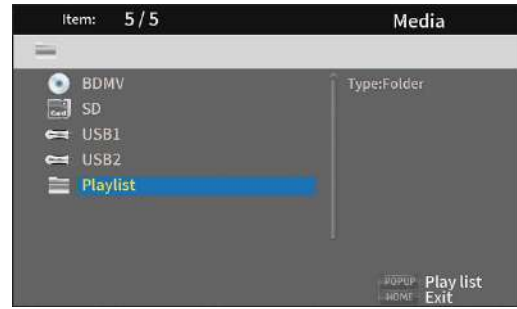

2. Opening the playlist folder will show the following folders.

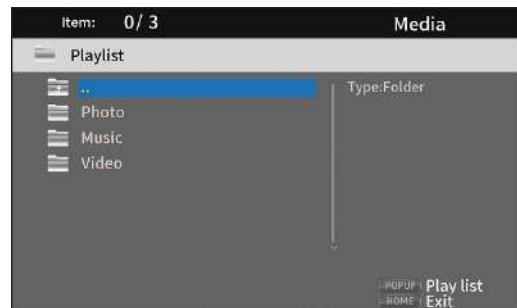

- ☐.. : Top folder
- Photo : Photo folder
- Music : Audio folder
- Video : Video folder

3. Select a file for playback, and press the ENTER or ► button to start playing the playlist





## Removing files from a playlist

1. To remove a file from a playlist, select the playlist icon and open the folder that contains the file.



2. To remove a specific file from the playlist, select it and press the > cursor button to add a check mark before its name.



At this point, press the TITLE/POP UP button to open a pop-up message. Then, use the ∨/∧ cursor buttons to select "Remove from Playlist" and press the ENTER button to remove files with check marks from the playlist.

3. To remove all files from the playlist, press the TITLE/POP UP button to open a pop-up message. Then, select "Select all" and press the ENTER button to add check marks to all files in the folder.

Press the TITLE/POP UP button again to open a pop-up message. Then, use the ∨/∧ cursor buttons to select "Remove from Playlist" and press the ENTER button to remove files with check marks from the playlist.

## Using program playback

This unit can play the content (titles/chapters or tracks) of video and audio discs in specified order.

### NOTE

The programmed content will be cleared in the following cases.

- When playback of the entire program completes, for example, and the HOME screen reopens
- When a disc is ejected
- When the power is turned off

1. First, press the PROG/RED button. The following Program page appears on the monitor.

### NOTE

Pressing the PROG/RED button again during this operation will clear the set content, restoring the default state.



DVD Screen



CD Screen

The Program screen shows the type of media that can have its playback order set (title/chapter or track), the total number of programmed items (15 maximum) and the names of the operation buttons (Play/Clear/Stop).

### Remote control button assignments

- Play: ► button
- Clear: CLEAR button
- Stop: RETURN button

2. On the Program screen, input the content to play in order from field ① using the procedures below. First, in field ①, press the ENTER button. Then use the ∨/∧ cursor buttons to select titles/chapters or tracks.



DVD Screen

For video discs, first use the  $\nabla/\wedge$  cursor buttons to select the number\* of the title to be played in the title input field. Then, use the  $\triangleright$  cursor button to move to the chapter input field, and use the  $\nabla/\wedge$  cursor buttons to select the number\* of the chapter to be played.

- Use the CLEAR button to reset the input number to 0.
- Press the RETURN button to cancel the program and close the Program page.  
(The input content will be cleared.)

\* Only values that exist in the disc content can be selected.



CD Screen

For audio discs, use the  $\nabla/\wedge$  cursor buttons to select the number\* of the track to be played in the track input field.

- Use the CLEAR button to reset the input number to 0.
- Press the RETURN button to cancel the program and close the Program page.  
(The input content will be cleared.)

\* Only values that exist in the disc content can be selected.

3. After inputting all the desired playback items, press the  $\blacktriangleright$  button to start program playback.

#### NOTE

When the Program page is open, only the following buttons can be used.

$\blacktriangleright$ , CLEAR, RETURN, cursor and number buttons

## Setting bookmarks

This unit can be used to set bookmarks to remember specific places on video discs.

To create a bookmark, press the MARK/GREEN button at the desired place during video playback.

- The internal memory can store a maximum of 12 bookmarks.
- The bookmark number, current title, chapter and time are shown on the monitor.

## Jumping to bookmarks

1. Press and hold the MARK/GREEN button for 6 seconds. Playback will pause, and available bookmarks will be shown on the monitor.
2. Use the  $\langle/\rangle$  cursor buttons to move between bookmarks. When a bookmark is selected, its number and the current title, chapter and time are shown on the monitor. Available bookmarks appear white, while unused bookmarks appear gray.
3. Press the ENTER button to jump to the target bookmark. Playback from that bookmark is possible. To cancel this operation and return to ordinary playback, press the MARK/GREEN button.

## Deleting bookmarks

1. Press and hold the MARK/GREEN button for 6 seconds. Playback will pause, and available bookmarks will be shown on the monitor.
2. To delete the last created bookmark, press the CLEAR/GREEN button.
3. Press the MARK/GREEN button to close the bookmarks and return to ordinary playback.

## Adjusting the volume from the unit

To adjust the volume during playback, use the  $-/+$  (VOLUME) buttons.



If the playback sound still cannot be heard after raising the volume some, adjust the volume on the monitor, TV, amplifier or other sound output equipment.

#### NOTE

If the remote control  $-/+$  (VOLUME) buttons do not function, on the HOME screen, select Settings > Audio Settings > Audio Output > Volume Control and set it to Enable.

## Muting with this unit

By pressing the MUTE button, playing sounds can be muted by this unit.

When muted, the  icon appears on the monitor. Press the MUTE button again to stop muting. The  icon appears on the monitor. (This icon will disappear from the monitor after a little while.)

## Overview of ON SCREEN information bar

Press the ON SCREEN button to open an information bar at top of the monitor screen.

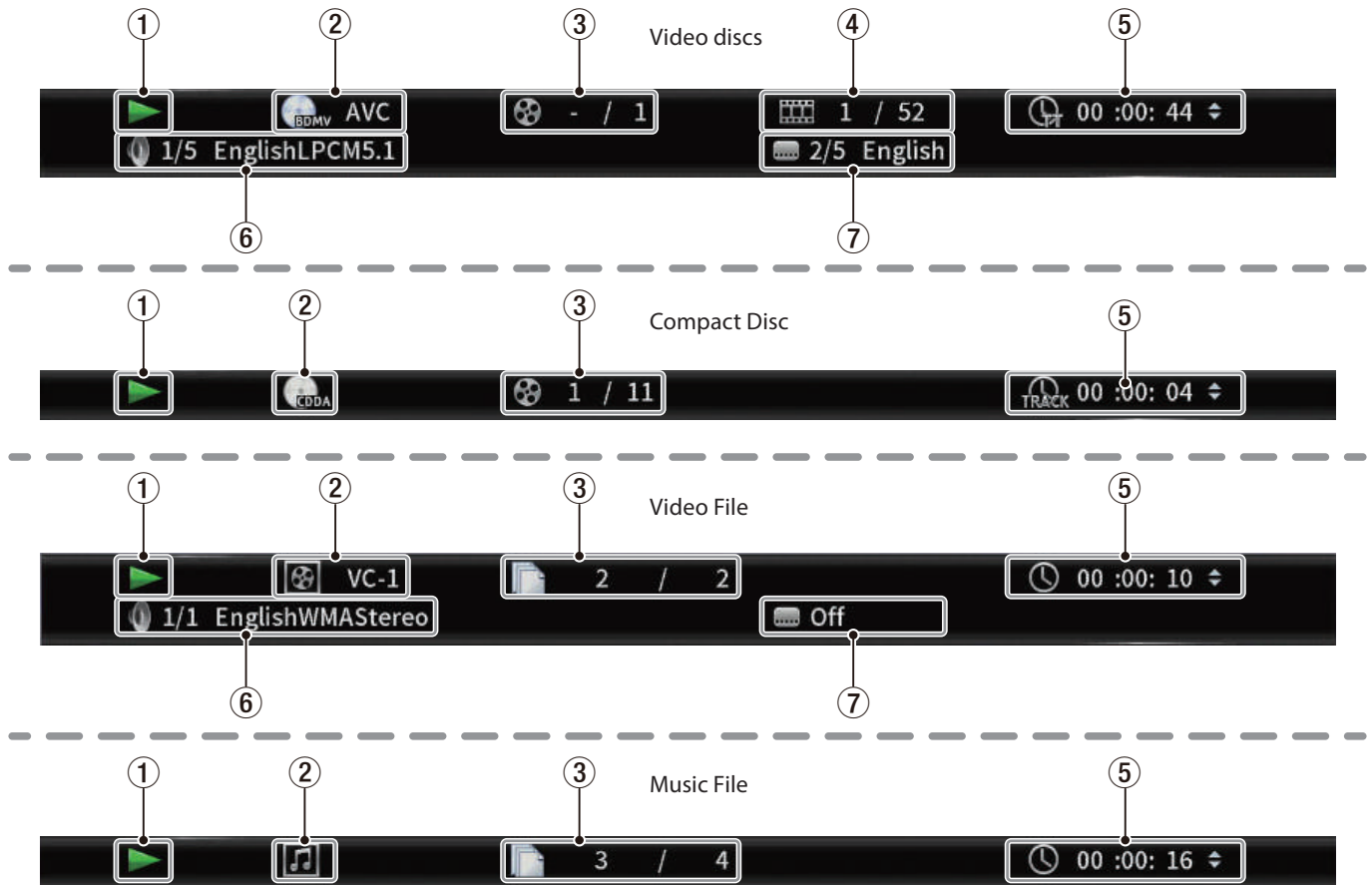

### ① Operation status

This shows the current operation status.

- ▶ : Playing
- ⏸ : Playback paused
- ◀◀X : Search backward X (1-5)
- ▶▶X : Search forward X (1-5)
- ⏮ : Skip backward
- ⏭ : Skip forward
- ⊘ : Operation not possible

### ② Media/file

This shows the type of the playing media/file.

### ③ Title/track

This shows the number of the current title/track.

### ④ Chapter

This shows the current chapter.

### ⑤ Playback time

This shows the current playback time.

Use the  $\vee/\wedge$  cursor buttons to change the time display.

#### During BDMV, DVD Video or other video playback

- Title elapsed time (TT)
- Title remaining time (-TT)
- Chapter elapsed time (CH)
- Chapter remaining time (-CH)

#### During CD playback

- Track elapsed time (Track)
- Track remaining time (-Track)
- Disc elapsed time (Disc)
- Disc remaining time (-Disc)

#### During file playback

- File elapsed time
- File remaining time

### ⑥ Audio settings

This shows the current audio settings.

Press the AUDIO button to change the available audio settings.

### ⑦ Subtitle language

This shows the current subtitle setting.

Press the SUBTITLE button to change the selectable subtitle language.

# Speaker Settings

## Configuration

From the Home Screen, use Settings > Audio Settings > Speaker Settings to set the speaker channel configuration.

- From the submenu Configuration, select the number of speakers.

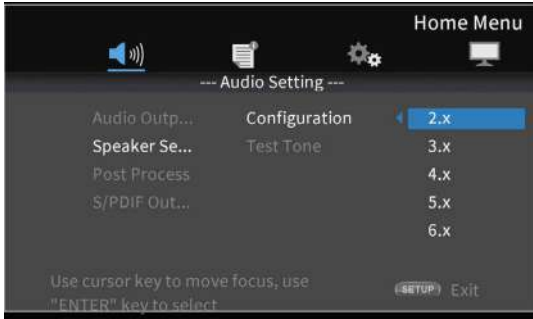

Use the > cursor or ENTER button to move to the function setting. Use the ^ and v cursor buttons to select the number of speakers to use, and press the ENTER button to confirm.

- Select the channel mode on the channel mode selection screen.

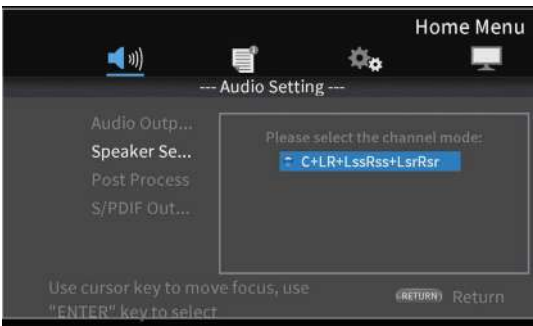

### Options

Number of speakers	Channel modes
2.x	Lt/Rt, Stereo
3.x	LCR
4.x	LRLsRs
5.x	None
6.x	None
7.x	C+LR+LssRss+LsrRsr

Use the ^ and v cursor buttons to select the channel mode, and press the ENTER button to confirm.

### NOTE

This screen will not be shown for some speaker number selections.

- Select the subwoofer on the Subwoofer Selection Screen.

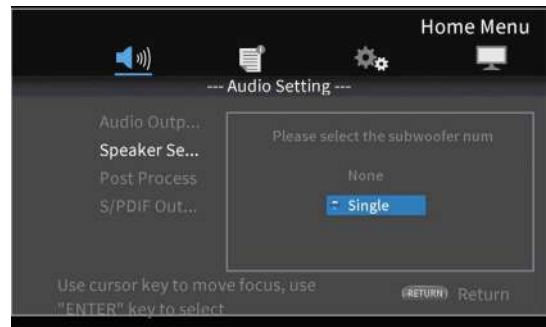

Use the ^ and v cursor buttons to select the subwoofer, and press the ENTER button to confirm.

- Use the Speaker Settings Screen to make settings for each speaker.



Example with 7.x and C+LR+LssRss+LsrRsr settings

Use the ^ and v cursor buttons to select the speaker to set, and press the ENTER button to confirm.

- Items that can be set for the selected speaker will be shown. Use the ^ and v cursor buttons to select the item to set, and press the ENTER button to confirm.



Press the RETURN button to return to speaker selection.

### NOTE

The only subwoofer setting that can be changed is trim.

6. Change the size.  
Use the  $\wedge$  and  $\vee$  cursor buttons to select the Size, and press the ENTER button to confirm. The size options (Large/ Small) will be shown.



Use the  $\wedge$  and  $\vee$  cursor buttons to select "Large" or "Small", and press the ENTER button to confirm.

**NOTE**

Different sizes cannot be selected for speakers in a pair.

7. Change the trim.  
Use the  $\wedge$  and  $\vee$  cursor buttons to select "Trim", and press the ENTER button to confirm. This opens the Trim Adjustment Screen.



C example

Use the  $\lt$  and  $\gt$  cursor buttons to change the value, and press the ENTER button to confirm.  
Adjustment range: 0 –  $\pm$ 10 dB (in 0.5dB increments)

**NOTE**

For pairs, only values that show a  $\blacktriangleleft$  or  $\blacktriangleright$  cursor can be changed. Use the  $\wedge$  and  $\vee$  cursor buttons to change them.

8. Change the delay.  
Use the  $\wedge$  and  $\vee$  cursor buttons to select "Delay", and press the ENTER button to confirm. This opens the Delay Adjustment Screen.



C example

Use the  $\lt$  and  $\gt$  cursor buttons to change the value, and press the ENTER button to confirm.

Adjustment range: 0 – 1000 cm (in 5cm increments)

**NOTE**

- The unit is centimeters. Measure the distances from each speaker to the listing point, calculate their differences and use these values. (The delay time is 29 $\mu$ sec/cm.)
- For pairs, only values that show a  $\blacktriangleleft$  or  $\blacktriangleright$  cursor can be changed. Use the  $\wedge$  and  $\vee$  cursor buttons to change them.

**Test Tone**

Test tones (white noise) can be output from each speaker to confirm their connections and adjust their trim values. They can also be used to change sizes and delay values.

1. On the Home Screen, select Settings > Audio settings > Speaker settings > Test Tone. This opens a Speaker Setting Screen with the currently set channel configuration.



Example with 7.x and C+LR+LssRss+LsrRsr settings

This outputs a test tone from the speakers in counterclockwise order starting from the L speaker.

Example:

when set to 7.x and C+LR+LssRss+LsrRsr, tones will be output in this order: LwCwRwRsswRsrwLsrwLsswL.

2. Press the ENTER button while a speaker is highlighted yellow to enable changing its speaker size, trim and delay settings.



The current size, trim and delay settings for the highlighted speaker and its paired speaker will be shown at the bottom left of the screen.



3. Use the same procedures as for channel configuration to adjust the size, trim and delay.

**NOTE**

The test tone cannot be used to adjust the subwoofer.

## Network connection overview

From the HOME screen, use Settings > General Settings > Network to set the network connection.

1. In the submenu, set "Internet Connection" to "Enable".

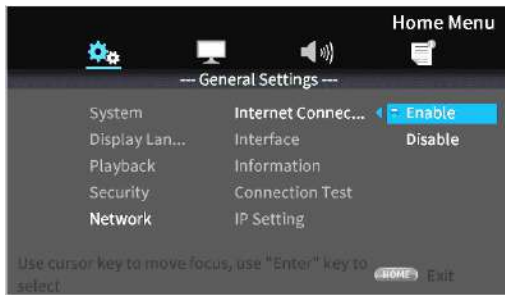

Use the > cursor or ENTER button to move to the function setting. Use the ∨/∧ cursor buttons to select "Enable" or "Disable" and press the ENTER button to confirm. To exit a folder or subfolder, press the < cursor button repeatedly to return to the starting screen.

2. Set the method of Internet access for the unit to "Ethernet" or "Wireless" in the submenu.

### NOTE

Wireless connection can only be used if a USB-wireless LAN adapter has been connected to the unit.



Use the > cursor or ENTER button to move to the function setting. Use the ∨/∧ cursor buttons to select "Ethernet" or "Wireless" and press the ENTER button to confirm. The following message will appear when the current setting is changed.

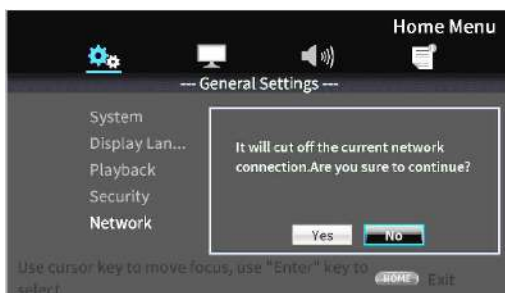

To connect, select "Yes" and press the ENTER button.

### Using a wireless connection

The following connection methods can be selected.

#### Scan

The unit will search for access points, allowing selection of a network.

#### Manual

An SSID can be set manually to connect.

#### Auto

Connection is possible using Wi-Fi Protected Setup (WPS) standards.

3. From the Information submenu, Network Information, the following screen can be checked.

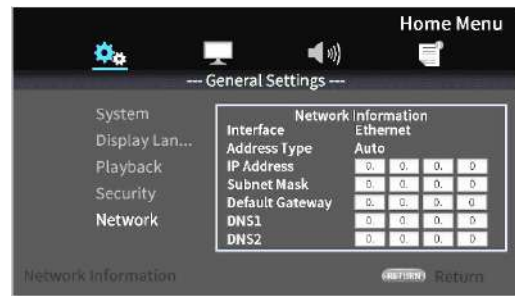

Press the RETURN Button to return to the previous screen.

### Information shown

Interface, address type, IP address, subnet mask, default gateway, DNS 1 and DNS 2

4. The network can be tested with "Connection Test" in the submenu. The following messages appear if there is a problem with the network connection.
  - "Network is FAILED ": Problem with network
  - "Proxy is FAILED ": Problem with proxy
5. Select how the unit's IP address is set in the IP Setting submenu.

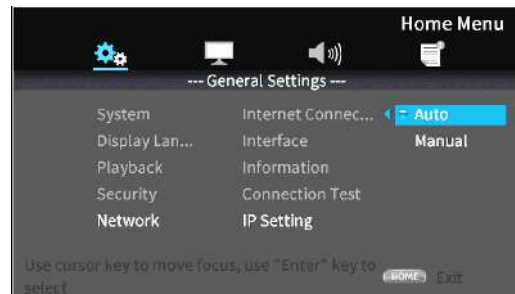

- Press the RETURN button even during an operation to return to the previous screen.
- If "Wireless" is selected in the submenu Interface setting, select "Wireless Setting" in the submenu to set the wireless connection. (The setting procedures are the same for the Interface settings.)

### Auto

Automatically acquire the IP address from a DHCP server.

### Manual: (see settings screen below)

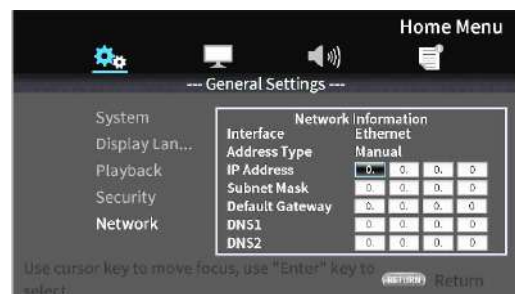

The cursor buttons can be used to select the IP address, subnet mask, default gateway, DNS1 and DNS2, and the number buttons can be used to input values.

## Option menus

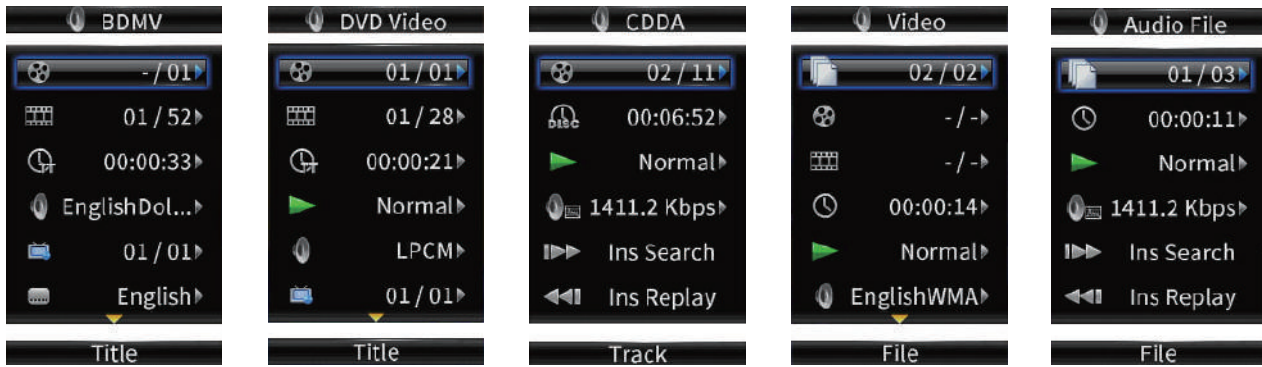

Using the option menu, specific settings can be made during playback without opening the Settings menu. Option menus appear on the left side of the monitor.

The available options depend on the type of media currently used.

Refer to the appropriate section according to the media type: BDMV options for Blu-ray discs, DVD Video options for DVDs, Video options for video files, Audio CD options for audio CDs, Audio File options for audio files and Image File options for image files.

To show and hide option menus, press the remote control OPTION button during playback.

### Basic option menu operations









- To move in a menu, use the j/k cursor buttons. The current item is shown in a blue frame.
- If an arrow (▶) appears to the right of a menu item, press the ENTER or > cursor button to open a submenu that contains additional options.
- If up/down arrows (▲/▼) appear in a submenu, the ∨ and ∧ cursor buttons can be used to select the previous and next options. Press the ENTER or < cursor button to confirm a selection and close the submenu.
- If no arrow appears to the right of an item, press the ENTER button to execute that function.





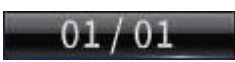

#### ATTENTION

Even if the time display is changed, the time shown on the main unit will return to its original state when the option menu screen is closed.

## General Settings

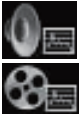







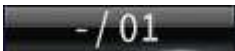

### BDMV options

Option menu name	Options	Explanation
 Title		The playing title can be changed. The number on the left is the currently playing title. The number on the right is the total number of titles.
 Chapter		The playing chapter can be changed. The number on the left is the currently playing chapter. The number on the right is the total number of chapters.
 Time	Hours: minutes: seconds	The elapsed time of the title or chapter. The time shown can be switched from title elapsed time (TT) to title remaining time (-TT), chapter elapsed time (CH) or chapter remaining time (-CH).
	00: 00: 00	
 Audio	(Depends on disc)	Audio settings can be changed. The audio settings that can be used depend on which are supported by the video. For example, DTS-HD MA (master audio) or Dolby Digital can be selected in various languages for Blu-ray discs.
 Angle		The camera angle can be changed. The number on the left is the current angle. The number on the right is the total number of available angles. This function can only be used with discs that have data for multiple angles.
 Subtitles	(Depends on disc)	Subtitle display can be changed. The settings that can be used depend on the subtitle languages supported by the video.
 Subtitle style	(Depends on disc)	The display style of subtitles can be changed. The settings that can be used depend on the subtitle languages supported by the video.





Option menu name	Options	Explanation
 Secondary video	On*, Off	This turns the picture-in-picture function on/off. Using this function, additional content can be shown in a small window during playback in the main window. This function can only be used with discs that support it.
 Secondary audio	On*, Off	The audio used by the picture-in-picture function can be turned on/off. This function can only be used with discs that support it.
 Bit rate	-	This is the current bit rate. The shown bit rate can be switched between video and audio.
 Image off	-	Press the ENTER button to turn the video image off, and continue playing only the audio. This function can only be used with discs that support it.
 Quick search	-	Press the ENTER button to search forward 30 seconds.
 Instant replay	-	Press the ENTER button to jump backward 10 seconds.
 CC Select	Analog CC 1 - 4, Off	Closed caption settings can be changed. This is set to Off when shipped new from the factory.

\* The content shown depends on the disc playing.

## DVD Video options













Option menu name	Options	Explanation
 Title		The playing title can be changed. The number on the left is the currently playing title. The number on the right is the total number of titles.
 Chapter		The playing chapter can be changed. The number on the left is the currently playing chapter. The number on the right is the total number of chapters.
 Time	Hours: minutes: seconds	The elapsed time of the title or chapter. The time shown can be switched from title elapsed time (TT) to title remaining time (-TT), chapter elapsed time (CH) or chapter remaining time (-CH).
	00: 00: 00	
 Mode	Normal, Shuffle CH Shuffle TT, Shuffle ALL Random CH, Random TT Random ALL	The file playback mode can be changed.
 Audio	(Depends on disc)	Audio settings can be changed. The audio settings that can be used depend on which are supported by the video. For example, DTS-HD MA (master audio) or Dolby Digital can be selected in various languages for Blu-ray discs.
 Angle	-	The camera angle can be changed. The number on the left is the current angle. The number on the right is the total number of available angles. This function can only be used with discs that have data for multiple angles.
 Subtitles	(Depends on disc)	Subtitle display can be changed. The settings that can be used depend on the subtitle languages supported by the video.
 Subtitle style	(Depends on disc)	The display style of subtitles can be changed. The settings that can be used depend on the subtitle languages supported by the video.
 Secondary video	On*, Off	This turns the picture-in-picture function on/off. Using this function, additional content can be shown in a small window during playback in the main window. This function can only be used with discs that support it.
 Secondary audio	On*, Off	The audio used by the picture-in-picture function can be turned on/off. This function can only be used with discs that support it.





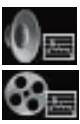



Option menu name	Options	Explanation
 Bit rate	-	This is the current bit rate. The shown bit rate can be switched between video and audio.
 Image off	-	Press the ENTER button to turn the video image off, and continue playing only the audio. This function can only be used with discs that support it.
 Quick search	-	Press the ENTER button to search forward 30 seconds.
 Instant replay	-	Press the ENTER button to jump backward 10 seconds.
 CC Select	Analog CC 1 - 4, Off	Closed caption settings can be changed. This is set to Off when shipped new from the factory.

\* The content shown depends on the disc playing.







## Video options

Option menu name	Options	Explanation
 File	-	The playing file can be changed. The number on the left is the currently playing file. The number on the right is the total number of video files in the folder.
 Title	-	The playing title can be changed. The number on the left is the currently playing title. The number on the right is the total number of titles.
 Chapter	-	The playing chapter can be changed. The number on the left is the currently playing chapter. The number on the right is the total number of chapters.
 Time	Hours: minutes: seconds	The elapsed time of the title or chapter. The time shown can be switched from title elapsed time (TT) to title remaining time (-TT), chapter elapsed time (CH) or chapter remaining time (-CH).
	00: 00: 00	
 Mode	Normally, Random, Shuffle	The file playback mode can be changed.
 Audio	(Depends on file)	Audio settings can be changed. The audio settings that can be used depend on which are supported by the video. For example, Stereo, Mono, Left and Right can be selected with video files.
 Subtitles	(Depends on file)	Subtitle display can be changed. The settings that can be used depend on the subtitle languages supported by the video.
 Code	-	The external subtitle code can be changed.
 Bitrate	-	This is the current bit rate. The shown bit rate can be switched between video and audio.
 Quick search	-	Press the ENTER button to search forward 30 seconds.
 Instant replay	-	Press the ENTER button to jump backward 10 seconds.
 CC Select	Analog CC1 - 4, Digital CS1 - 6, Off	Closed caption settings can be changed. This is set to Off when shipped new from the factory.





## Audio CD options

Option menu name	Options	Explanation
 Track	-	The playing track can be changed. The number on the left is the currently playing track. The number on the right is the total number of tracks on the disc or in the program.
 Time	Hours: minutes: seconds	Track or disc elapsed time.
	00: 00: 00	The time shown can be switched from track elapsed time (Track) to track remaining time (-Track), disc elapsed time (Disc) or disc remaining time (-Disc).
 Mode	Normally, Random, Shuffle	The file playback mode can be changed.
 Bit rate	-	This is the current audio bit rate.
 Quick search	-	Press the ENTER button to search forward 30 seconds.
 Instant replay	-	Press the ENTER button to jump backward 10 seconds.

## Audio file options

Option menu name	Options	Explanation
 File	-	The playing file can be changed. The number on the left is the currently playing file. The number on the right is the total number of audio files in the folder or playlist.
 Time	Hours: minutes: seconds	This is the file elapsed time.
	00: 00: 00	The time shown can be switched from the file elapsed time to the file remaining time.
 Mode	Normally, Random, Shuffle	The file playback mode can be changed.
 Bit rate	-	This is the current audio bit rate.
 Quick search	-	Press the ENTER button to search forward 30 seconds.
 Instant replay	-	Press the ENTER button to jump backward 10 seconds.

## Image File options

Option menu name	Options	Explanation
 File	-	The file being shown can be changed. The number on the left is the currently shown file. The number on the right is the total number of image files in the folder.
 Mode	Normally, Random, Shuffle	The file display mode can be changed.
 Slideshow speed	Slow, Middle, Fast	The slideshow speed can be changed. This is set to Middle when shipped new from the factory.
 Transitions	None, Wipe Left, Wipe Right, Wipe Up, Wipe Down, Box In, Box Out, Blending, Dissolve, Interlace H, Interlace V, Split In H, Split In V, Split Out H, Split Out V	The transition used between slideshow images can be changed. This is set to None when shipped new from the factory.

---

## Troubleshooting

---

If you are having trouble with the operation of this unit, please try the following before seeking repair.

If these measures do not solve the problem, please contact the store where you bought the unit or TASCAM customer support service.

### **The unit will not turn on.**

- Confirm that the power plug and other connectors are inserted completely.

### **Turning the TV off causes this unit to automatically turn off. (Turning this unit on also causes the TV to automatically turn on.)**

- When used with a TV that supports CEC link functions, if CEC link control is set to ON for this unit, the power for the TV and this unit will be linked, causing one to turn on/off automatically. (Depending on the TV being used, it might not automatically turn on.)

### **The unit does not function.**

- Confirm that the lock function is not on.
- When operation is prohibited, “” or a message will appear.

### **The Settings screen or its submenus cannot be selected or opened.**

- Sometimes settings and items cannot be selected or shown.

### **The disc tray cannot be opened or closed.**

- The disc tray cannot be opened or closed during software (firmware) updates.
- If a disc that cannot be used by this unit is loaded in it, the tray might stop opening and closing.
- Confirm that the tray lock function is not on.

### **Operations are not possible for a while after the disc is loaded.**

- Some time is necessary for the unit to recognize the disc and read its information before the disc can be used.

### **SD card/USB flash drive is not recognized.**

- Confirm that the SD card/USB flash drive is inserted securely.
- Is the connected SD card/USB flash drive supported by the unit?
- Check the format (file system) of the SD card/USB flash drive.
- Stop playback or recording once.

### **Sometime after connecting a SD card/USB device, the unit stopped responding to operations.**

- A problem has occurred during playback from the SD card/USB device, making operation of the unit impossible. Disconnect and reconnect the SD card/USB device.

### **The remote control (RC-BDMP1MKII) does not function.**

- Confirm that a battery is installed and has not died.
- Confirm that the remote control code setting is correct.
- Confirm that the lock function is not being used to lock the remote control, the buttons on the remote control and the main unit, or the remote control and the display.

### **The playback screen does not appear.**

- Is the TV input set to the input connected to this unit?
- Display at the selected resolution might not be possible. Press the HDMI button on the remote control to change the resolution setting.

### **A disc cannot be played.**

- Confirm that the disc format is supported by this unit.
- Confirm that the disc is not scratched or dirty.

### **A file on a disc cannot be played.**

- Confirm that the disc is recorded in UDF, ISO9660 or JOLIET format.
- Confirm that the file format is supported by this unit.

### **A file desired for playback cannot be found.**

- Confirm that the maximum file number has not been exceeded.
- Check the file extension.

### **No sound is output.**

- Check connections with the monitoring system again. Check the volume of the amplifier as well.

### **There is noise.**

- Confirm that the connection cables do not have contact issues.

### **Video or audio stops momentarily.**

- During playback of a dual layer disc, video or audio might stop temporarily when switching from the first layer to the second.
- If a disc has scratches or fingerprints on its surface, for example, it might not play properly.

### **Something is wrong with the screen size.**

- Has the TV Screen setting been set according to the TV format?  
If the screen size is specified by the disc, a size other than the set screen size might be used.

### **“” appears.**

- The operation is prohibited by the content during playback.

### **Operations are not possible during playback.**

- Some discs prohibit operations.
- With some discs, the unit cannot be used to change the playback speed, for example.

### **Playback will not start when a title is selected.**

- Playback might be prohibited by parental controls. Check the “Parental Control” setting.

### **The HOME screen will not open.**

- If the HIDE MENU function is on, the HOME screen will not open and the screen will remain black even if the HOME button is pushed.

When the HIDE MENU function is on, an \* will be shown at the right end of the bottom line on the display. (See  in “Normal state” on page 25)

To open the HOME screen, press the HIDE MENU button on the unit remote control to turn the HIDE MENU function off.

**During playback, video is disrupted, does not appear or has a strange color.**

- When searching forward or backward, for example, the video might appear a little irregular.
- Is a mobile phone or other device that emits radio waves being used nearby?
- Has a disc that is not supported by the unit or that has a different region code been loaded in it.
- Does the TV support HDCP?
- With the power on, try disconnecting the HDMI cable from the TV and this unit and then reconnecting it.
- Use a different HDMI cable and reconnect them.
- Check the "Display Settings" setting.

**Subtitles do not appear.**

- Subtitles cannot be turned on for titles without subtitle data.

**No audio is output from the AV amplifier.**

- Confirm that the AV amplifier is turned on.
- Confirm that the AV amplifier output is correct.
- Confirm that the AV amplifier supports bitstream or LPCM.
- Check the volume of the AV amplifier.

**The camera angle cannot be changed.**

- Angles cannot be changed for BD-Video or DVD-Video that does not have multiple angles recorded.
- Camera angles can only be changed for scenes that have it enabled.

**High definition resolution cannot be viewed.**

- Confirmed that the title recorded in high definition.
- Does the TV connected to the unit support high definition?

**HDMI device control does not work.**

- HDM device control only works when the necessary settings have been made for this unit and the other supported device.
- When HDMI device control is enabled, it will be disabled if the power plug of this device or the HDMI cable is disconnected.

**Cannot connect to a network.**

- Confirm that the modem and router are turned on.
- Confirm that the modem and router Internet indicators are lit.
- Check the unit's Network settings.
- Confirm that this unit and router are connected correctly.
- Confirm that the router DHCP function is enabled.

**A password was forgotten.**

- If it has been forgotten, contact TASCAM customer support service.

## Specifications

### General

#### Supported media

##### Disc media

Blu-ray	BD25, BD50, BD-ROM, BD-R(SL, DL), BD-RE(SL, DL)
DVD	DVD-ROM, DVD-R(SL,DL), DVD-RW, DVD+R(SL,DL), DVD+RW
CD	CD-DA, CD-R, CD-RW

- SL indicates single-layer discs and DL indicates double-layer discs
- This unit can play only BD and DVD-VIDEO that has the same region code as shown on the label on its chassis. It can also play DVD-VIDEO that is ALL.

##### Disc formats

Blu-ray	BDMV, BDAV
DVD	DVD-Video, DVD-VR, AVCHD

- Blu-ray 3D supported

##### Supported file formats\*

Video	ASF, MPG, AVI, 3GP, DAT, MKV, MOV, M2TS, OGM, TP, TS, MP4, WMV
Audio	WAV, MP3, WMA, AAC, FLAC, APE
Picture	JPEG, GIF, PNG
Supported subtitle file formats	SUB, ASS, IDX+SUB(IDX+SUB)

\* USB flash drive and SD card formats must use FAT16, FAT32, exFAT or NTFS file systems.

### Audio

#### BD/DVD/USB/SD

Sampling frequency	44.1 k/48 k/64 k/88.2 k/96 k/176.4 k/192 kHz
Bit length	16/24 bit

#### CD

Sampling frequency	44.1 kHz/48 kHz
Bit length	16/24 bit

#### MP3/WMA

Sampling frequency	32 k/44.1 k/48 kHz	
Bitrate	MP3	112 kbps - 320 kbps
	WMA	48 kbps - 192 kbps

### Outputs

#### HDMI output

Connector	HDMI 19pin Type A
Resolution	480i/576i/480p/576p/720p/1080p
Aspect ratio	16:9 Full, 16:9 Normal, 4:3 Pan & Scan, 4:3 Letterbox
Video format	NTSC, PAL, Multi
HDMI signal system	RGB PC level, RGB Video level, YCbCr(4:4:4), YCbCr (4:2:2)

#### Digital Audio output

##### COAXIAL

Connectors	RCA pin jacks
Format	IEC60958-3(S/PDIF)
Output impedance	75 Ω or lower

## Analog audio outputs

### Balanced

Connectors	XLR-3-32 (1: GND, 2: HOT, 3: COLD) x2 (Stereo)
Nominal output level	+4 dBu (1.23 Vrms)
Maximum output level	+20 dBu (7.75 Vrms)
Output impedance	200 Ω or lower

### Unbalanced

Connectors	RCA pin jack x 1 pair
Nominal output level	-10 dBV (0.316 Vrms)
Nominal output level	+6 dBV (2.0 Vrms)
Output impedance	210 Ω or less

### 7.1ch Audio outputs

Connectors	RCA x8 (FL/FR/SL/SR/SBL/SBR/C/SW)
Connector Color	FL, SL, SBL-White FR, SR, SBR-Red C, SW-Black
Nominal output level	-10 dBV (0.316 Vrms)
Maximum output level	+6 dBV (2.0 Vrms)
Output impedance	210 Ω or less

0dBu = 0.775 Vrms

0dBV = 1 Vrms

## Control input/output

### RS-232C connector

Connector	D-sub 9 pin
Format	RS-232C compliant

### Ethernet connector

Connectors	RJ-45
Protocol	10 BASE-T/100 BASE-TX
Cable	Category 5e or faster

### USB port

Connectors	USB type-A x2 (front x1, back x1)
Protocol	USB 2.0 compliant
Rated supply voltage	DC 5 V, 1 A
Mass storage class	Less than 2 TB
Supported file formats	FAT16/FAT32/exFAT/NTFS
USB device class	Mass storage class

### SD slot

Supported media	SD (512 MB-2 GB), SDHC (4 GB-32 GB), SDXC (64GB - 512GB)
Supported file formats	FAT16/FAT32/exFAT/NTFS

## Audio performance

Frequency response	20 Hz - 20 kHz +/-0.5 dB (Fs=44.1 kHz/48 kHz, JEITA)
S/N ratio	96 dB or higher (during playback, JEITA)
THD (Total Harmonic Distortion)	0.03% or less 1 kHz (JEITA)
Dynamic range	96 dB or higher (JEITA)
Channel separation	89 dB or higher (JEITA)

JEITA: indicates compliance with JEITA CP-2150

## Other

### Power

AC100 - 240 V, 50/60 Hz

### Power consumption

30 W

### Dimensions (W x H x D, Including protrusions)

482.8 x 44 x 280.7 mm

### Weight

2.64 kg

### Operating temperature range

5 °C - 35 °C (41°F - 95°F)

## Dimensional drawings

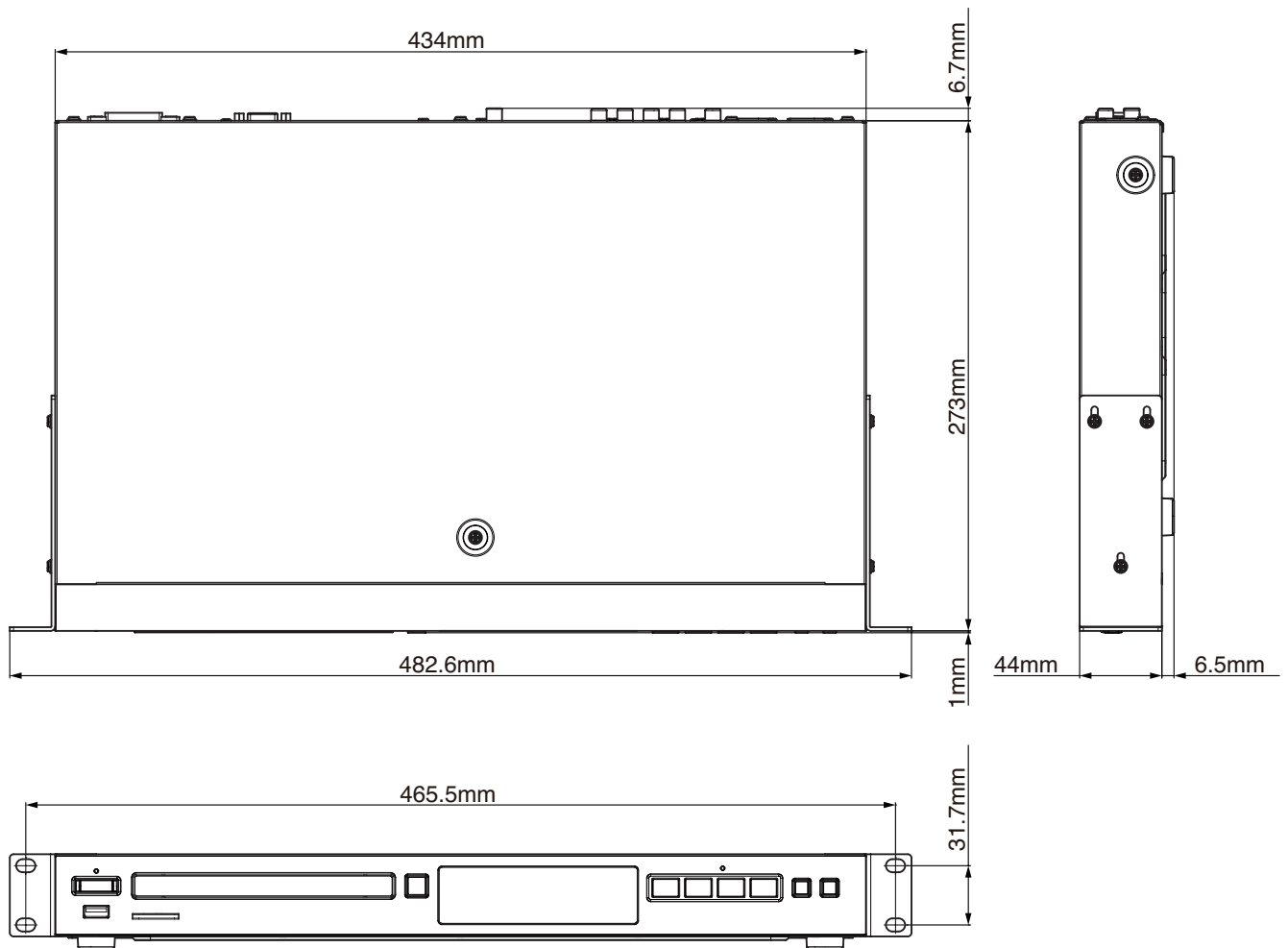

- Illustrations in this manual might differ in part from the actual product.
- Specifications and external appearance might be changed without notification to improve the product.

---

## Notice regarding software that uses the GNU GPL

---

### List of packages

GNU GPLv2: linux kernel

GNU LGPLv2.1: DirectFB

---

### About the licensing of software used in this product

The software included in this product is comprised of multiple discrete software applications, and the copyrights of each of these belong to various third parties.

This product includes software covered by end-user license agreements (hereafter, "EULA") stipulated by third parties.

Among these is the GNU General Public License (hereafter, "GPL") for free executable software applications. As a condition for the distribution of software covered by the GPL, the source code for such software must be made available. If you wish to obtain the source code for such software, you may do so by accessing the following URL and filling out a registration form.

Home page address

**<https://teac-global.com/support/opensource/form/>**

Please understand that we are unable to respond to questions about the source code contents and similar matters.

Source code will not be provided for software covered by EULAs other than the GPL.

Software distributed in accordance with the GPL allows customers to use it without charge, but, to the extent of applicable laws, no explicit or implicit guarantees are provided for such software.

With the exceptions of provisions of applicable laws and written agreements, the copyright holders and those who change and redistribute such software with the permission described above will bear no responsibility for any loss caused by the use of or the inability to use such software. Please read the GPL for details about, for example, conditions for use and provisions that must be followed regarding such software.

For details about use requirements for the covered software modules and other matters, from the Home Screen, open Settings > General Settings > System > Copyrights, and read the various software user license agreements. (The original texts are presented because these are rules from third parties, not from TEAC.)





## WARRANTY

### < In the United States >

This warranty gives you specific legal rights and you may also have other rights which vary from state to state. This warranty is only valid within the country the unit was originally purchased.

#### WHAT IS COVERED AND WHAT IS NOT COVERED

Except as specified below, this warranty covers all defects in materials and workmanship in this product. The following are not covered by the warranty:

1. **Damage to or deterioration of the external cabinet.**
2. **Damage resulting from accident, misuse, abuse or neglect.**
3. **Damage resulting from failure to perform basic daily maintenance and/or calibration or otherwise resulting from failure to follow instructions contained in your owner's manual.**
4. **Damage occurring during shipment of the product. (Claims must be presented to the carrier)**
5. **Damage resulting from repair or attempted repair by anyone other than TEAC or an authorized TASCAM service station.**
6. **Damage resulting from causes other than product defects, including lack of technical skill, competence, or experience of the user.**
7. **Damage to any unit which has been altered or on which the serial number has been defaced, modified or is missing.**

#### WHO IS COVERED UNDER THE WARRANTY

This warranty may be enforced only by the original purchaser. This warranty is not valid if the product was purchased through an unauthorized dealer.

#### LENGTH OF WARRANTY

All parts except heads and disk drives are warranted for one (1) year from the date of original purchase. Heads and disk drives are warranted for ninety (90) days from date of original purchase. Labor is warranted for ninety (90) days from date of original purchase.

#### WHAT WE WILL PAY FOR

We will pay all labor and material expenses for items covered by the

warranty. Payment of shipping charges is discussed in the next section of this warranty.

#### HOW YOU CAN GET WARRANTY SERVICE

Your unit must be serviced by an authorized TASCAM service station in the United States. (This warranty is not enforceable outside the U.S.) If you are unable to locate an authorized TASCAM service station in your area, please contact us. We either will refer you to an authorized service station or instruct you to return the unit to the factory. Whenever warranty service is required, you must present a copy of the original dated sales receipt from an Authorized TASCAM Dealer.

You must pay any shipping charges if it is necessary to ship the product to service. However, if the necessary repairs are covered by the warranty, we will pay return surface shipping charges to any destination within the United States.

#### LIMITATION OF IMPLIED WARRANTIES

Any implied warranties, INCLUDING WARRANTIES OF MERCHANTABILITY AND FITNESS FOR A PARTICULAR PURPOSE, are limited in duration to the length of this warranty.

#### EXCLUSION OF DAMAGES

TEAC's liability for any defective product is limited to repair or replacement of the product, at TEAC's option. TEAC shall not be liable for:

1. **Damages based upon inconvenience, loss of use of the product, loss of time interrupted operation or commercial loss; or**
2. **Any other damages, whether incidental, consequential or otherwise.**

Some states do not allow limitations on how long an implied warranty lasts and/or do not allow the exclusion or limitation of incidental or consequential damages, so the above limitations and exclusions may not apply to you.

#### To locate an Authorized Service Center in Your Area

CALL 1-323-726-0303

### < Europe >

This product is subject to the legal warranty regulations of the country of purchase. In case of a defect or a problem, please contact the dealer where you bought the product.

Ce produit est sujet aux réglementations concernant la garantie légale dans le pays d'achat. En cas de défaut ou de problème, veuillez contacter le revendeur chez qui vous avez acheté le produit.

Dieses Gerät unterliegt den gesetzlichen Gewährleistungsbestimmungen des Landes, in dem es erworben wurde. Bitte wenden Sie sich im Gewährleistungsfall an den Händler, bei dem sie das Gerät erworben haben.

Questo apparecchio è conforme alle norme sulla garanzia vigenti nel rispettivo Paese in cui esso è stato acquistato. Si prega di rivolgersi al proprio commerciante, presso il quale è stato acquistato l'apparecchio, nel caso in cui si voglia richiedere una prestazione in garanzia.

Las condiciones de garantía de este aparato están sujetas a las disposiciones legales sobre garantía del país en el que ha sido adquirido. En caso de garantía, debe dirigirse al establecimiento donde adquirió el aparato.

### < In other countries/areas >

This warranty gives you specific legal rights, and you may also have other rights that vary by country, state or province.

If you have a warranty claim or request, please contact the dealer where you bought the product.

该保证书赋予了顾客特定的合法权利，并且因国家、州或省等地域的不同，顾客可能拥有其他权利。如需申请或要求保修，请与购买本产品的销售店进行联系。

If you require repair services for your TASCAM equipment, please contact the dealer where the product was purchased from or the TASCAM Distributor in your country. A list of TASCAM Distributors can be found on our website at: <https://teac-global.com/>

# TASCAM

TEAC CORPORATION  
Phone: +81-42-356-9143  
1-47 Ochiai, Tama-shi, Tokyo 206-8530 Japan

<https://tascam.jp/jp/>

TEAC AMERICA, INC.  
Phone: +1-323-726-0303  
10410 Pioneer Blvd., Unit #3, Santa Fe Springs, California 90670, U.S.A

<https://tascam.com/us/>

TEAC UK Ltd.  
Phone: +44-1923-797205  
Luminous House, 300 South Row, Milton Keynes, Buckinghamshire, MK9 2FR, UK

<https://www.tascam.eu/en/>

TEAC EUROPE GmbH  
Phone: +49-611-71580  
Bahnstrasse 12, 65205 Wiesbaden-Erbenheim, Germany

<https://www.tascam.eu/de/>

TEAC SALES & TRADING(SHENZHEN) CO., LTD  
Phone: +86-755-88311561~2  
Room 817, Xinian Center A, Tairan Nine Road West, Shennan Road, Futian District, Shenzhen, Guangdong Province 518040, China

<https://tascam.cn/cn/>

Printed in China

0124.MA-3745A

## WARRANTY

Model / Modèle / Modell  
Modello / Modelo / 型号

**BD-MP1 MKII**

Serial No. / No de série / Seriennummer  
Numero di serie / Número de serie / 序列号

Date of purchase / Date de l'achat / Datum de Kaufs  
Data dell'acquisto / Fecha de compra / 购买日期

**TASCAM**

<https://teac-global.com/>

Owner's name / Nom du propriétaire / Name des Eigentümers  
Nome del proprietario / Nombre del propietario / 顾客姓名

Address / Adresse / Adresse  
Indirizzo / Dirección / 顾客地址

Dealer's name / Nom du revendeur / Name des Händlers  
Nome del commerciante / Nombre del establecimiento / 销售店名

Dealer's address / Adresse du revendeur / Adresse des Händlers  
Indirizzo del commerciante / Dirección del establecimiento / 销售店

**Sample**

